

## DMX9720XDS

### MONITOR WITH RECEIVER INSTRUCTION MANUAL

JVCKENWOOD Corporation

- Updated information (the latest Instruction Manual, system updates, new functions, etc.) is available from <https://www.kenwood.com/cs/ce/>.
- The Instruction manual is subject to change for modification of specifications and so forth. Be sure to download the latest edition of the Instruction manual for reference. <https://manual.kenwood.com/edition/im406/>



**android**  
**auto**



Hi-Res Audio logo and Hi-Res Audio Wireless logo are used under license from Japan Audio Society.



# Contents

## **Before Use 4**

Precautions.....	4
How to read this manual .....	4

## **Basic Operations 5**

Functions of the Buttons on the Front Panel ...	5
Turning on the Unit .....	6
Initial Settings.....	6
Adjusting the volume .....	8
Touch screen operations .....	9
HOME screen descriptions.....	9
Popup menu .....	10
Source selection screen description.....	10
Source control screen descriptions .....	12
List screen .....	13

## **Widget 14**

Widget.....	14
Drive Widget Panel .....	14
Importing Image Files.....	15

## **APPS 16**

Wireless Mirroring Operation.....	16
Apple CarPlay Operation .....	16
Android Auto Operation.....	18
KENWOOD Traffic Powered By INRIX.....	20

## **USB 21**

Connecting a USB device .....	21
USB Basic Operation.....	21
Search Operation.....	23

## **iPod/iPhone 24**

Preparation .....	24
iPod/iPhone Basic Operation .....	25
Search Operation.....	26

## **Radio 27**

Radio Basic Operation .....	27
Memory Operation .....	28
Selecting Operation .....	29
Traffic Information .....	29
Radio SETUP .....	30

## **Digital Radio 31**

Digital Radio Basic Operation .....	31
Storing Service in Preset Memory .....	32
Selecting Operation .....	32
Traffic Information .....	33
Digital Radio SETUP.....	34

## **Bluetooth Control 35**

Information for using Bluetooth® devices.....	35
Register the Bluetooth device .....	36
Bluetooth Setup.....	38
Playing the Bluetooth Audio Device .....	39
Using the Hands-Free Unit.....	41
Hands-Free Setup.....	46

## **Other External Components 47**

View Camera .....	47
Use Dashboard Camera.....	49
External audio/video players (AV-IN).....	50
HDMI source.....	50

<b>Setup</b>	<b>51</b>
Monitor Screen Setup .....	51
Connections & AV Setup .....	51
Display & Button Setup .....	53
User Interface Setup.....	55
System Setup .....	56
<b>Controlling Audio</b>	<b>57</b>
3-way speaker system setup .....	57
Speaker / X'over setup .....	58
Equalizer Control .....	59
Listening Position / DTA .....	60
Fader / Balance / Zone Control .....	62
Volume Offset .....	64
Sound Effect .....	64
Parametric Equalizer.....	65
Audio Setup memory .....	68
<b>Remote control</b>	<b>69</b>
Battery Installation.....	69
Functions of the Remote control Buttons .....	69
<b>Connection/Installation</b>	<b>72</b>
Before Installation .....	72
Installing the unit .....	75
<b>Troubleshooting</b>	<b>85</b>
Problems and Solutions .....	85
Error Messages .....	86
<b>Appendix</b>	<b>87</b>
Playable Media and Files.....	87
Specifications.....	89
About this Unit .....	92

# Before Use

## Precautions

### ▲ WARNINGS

#### ■ To prevent injury or fire, take the following precautions:

- To prevent a short circuit, never put or leave any metallic objects (such as coins or metallic tools) inside the unit.
- Do not watch or fix your eyes on the unit's display when you are driving for any extended period.
- If you experience problems during installation, consult your KENWOOD dealer.

#### ■ Precautions on using this unit

- When you purchase optional accessories, check with your KENWOOD dealer to make sure that they work with your model and in your area.
- You can select a language to display menus, audio file tags, etc. See **System Setup (P.56)**.
- The Radio Data System feature won't work in areas where the service is not supported by any broadcasting station.

#### ■ Protecting the monitor

- To protect the monitor from damage, do not operate the monitor using a ball point pen or similar tool with a sharp tip.

#### ■ Cleaning the unit

- If the faceplate of this unit is stained, wipe it with a dry soft cloth such as a silicon cloth. If the faceplate is stained badly, wipe it with a cloth moistened with neutral cleaner, then wipe it again with a clean soft dry cloth.

#### NOTE

- Applying spray cleaner directly to the unit may damage its mechanical parts. Wiping the faceplate with a hard cloth or using a volatile liquid such as thinner or alcohol may scratch the surface or erase the screened print.

#### ■ Acquiring GPS signal

The first time you turn on this unit, you must wait while the system acquires satellite signals for the first time. This process could take up to several minutes. Make sure your vehicle is outdoors in an open area away from tall buildings and trees for fastest acquisition.

After the system acquires satellites for the first time, it will acquire satellites quickly each time thereafter.

#### ■ About GLONASS

This unit uses Global Navigation Satellite System (GLONASS) in addition to GPS.

Combining GPS and GLONASS can refine positioning accuracy than using GPS only.

#### ■ Caution for Smartphone Users

Simultaneously running multiple applications on your smartphone while screen sharing places heavy demand on the microprocessor of the phone, potentially affecting communication and performance.

For best results while pairing with your KENWOOD receiver, please be sure to close any unused applications.

## How to read this manual

- The screens and panels shown in this manual are examples used to provide a clear explanation of operations. For this reason, they may be different from the actual screens or panels, or some display patterns may be different from the actual ones.
- **Display language:** English is used for the purpose of explanation. You can select a display language from the **SETUP** menu. See **System Setup (P.56)**.

# Basic Operations

## Functions of the Buttons on the Front Panel

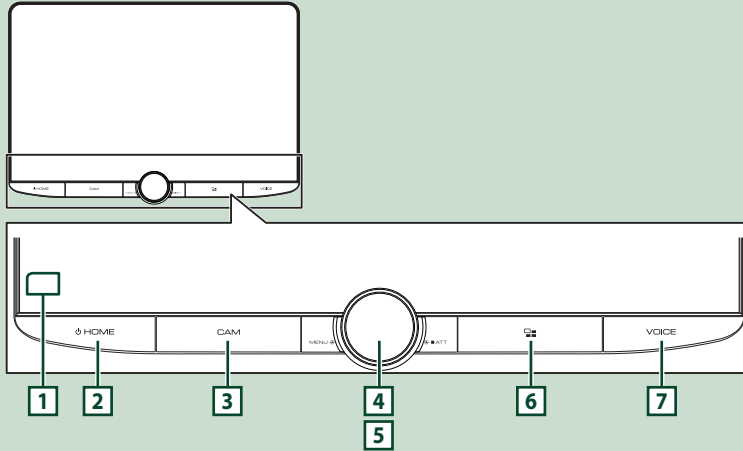

Number	Name	Motion
1	Remote Sensor	<ul style="list-style-type: none"> <li>Receives the remote control signal.</li> </ul>
2	HOME/⏻	<ul style="list-style-type: none"> <li>Displays the HOME screen (P.9).</li> <li>Pressing for 1 second turns the power off.</li> <li>When the power is off, turns the power on.</li> </ul>
3	CAM	<ul style="list-style-type: none"> <li>Switches view camera display on/off. (P.47)</li> </ul> <p>The camera whose view is displayed first changes according to the Camera Assignment Settings (P.48) and the shift lever position in the shift gate. The camera whose view was displayed last is kept and the same camera view will be displayed the next time. If its assignment setting is changed, the rear camera view is displayed.</p>
4	MENU/ATT	<ul style="list-style-type: none"> <li>Displays the popup menu screen.</li> <li>Pressing for 1 second switches attenuation of the volume on/off.</li> </ul>
5	Volume knob	<ul style="list-style-type: none"> <li>Adjusts the volume. (P.8)</li> </ul>
6		<ul style="list-style-type: none"> <li>Displays the APP (Apple CarPlay/Android Auto/Wireless Mirroring) screen.</li> <li>While the APP screen is displayed, switches to the control screen of current source.</li> </ul>
7	VOICE	<ul style="list-style-type: none"> <li>Switches the voice recognition function on/off. (P.18, P.20, P.43)</li> <li>When neither Apple CarPlay, Android Auto, nor a Bluetooth Hands-Free phone is connected, pressing and holding displays Bluetooth pairing waiting dialog. (P.36)</li> </ul>

## Turning on the Unit

- 1 Press the **HOME** /  button.

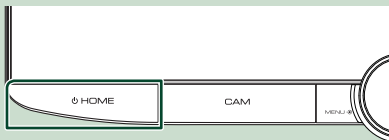

➤ The unit is turned on.

### ● To turn off the unit:

- 1 Press the **HOME** /  button for 1 second.

#### NOTE

- If it is your first time to turn the unit on after installation, it will be necessary to perform Initial SETUP (P.6).

## Initial Settings

### Initial SETUP

Perform this setup when you use this unit first time.

- 1 Set each item as follows.

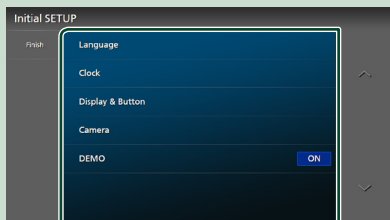

#### ■ Language

Select the language used for the control screen and setting items. Default is "British English(en)".

- ① Touch **Language**.
- ② Touch **Language Select**.
- ③ Select the desired language.
- ④ Touch .

For details, see **System Setup (P.56)**.

#### ■ Clock

Sets the synchronization of the clock and adjusts it.

For detailed operation, see **Calendar/clock settings (P.8)**.

#### ■ Display & Button

Set the button illumination color.

- ① Touch **Display & Button**.
- ② Touch **Button Illumination Colour**.
- ③ Select the desired color.
- ④ Touch .

For details, see **Display & Button Setup (P.53)**.

#### ■ Camera

Set the parameters for the camera.

- ① Touch **Camera**.
- ② Set each item and touch .

For details, see **Camera Setup (P.47)**.

#### ■ DEMO

Set the demonstration mode. Default is "ON".

- 2 Touch **Finish**.

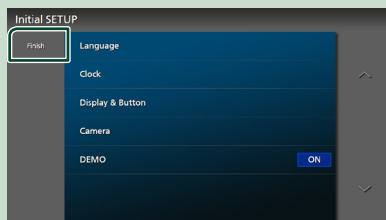

#### NOTE

- These settings can be made from the SETUP menu. See **Setup (P.51)**.



## Security Code Setup

You can set up a security code to protect your receiver system against theft.

When the Security Code function is activated, the code cannot be changed and the function cannot be released. Note the Security Code can be set as the 4 to 8 digit number of your choice.

### Preparation

- Set **DEMO** to **OFF** in the System setting menu screen (P.56).

- 1 Press the **HOME** /  button.
- 2 Touch .
- 3 Touch **SETUP** .
  - SETUP Menu screen appears.
- 4 Touch **System** .
  - System setting menu appears.
- 5 Touch **Security Code Set** in the system setting menu.
  - Security Code Set screen appears.
- 6 Enter a security code with 4 to 8 digit number and touch **Enter** .

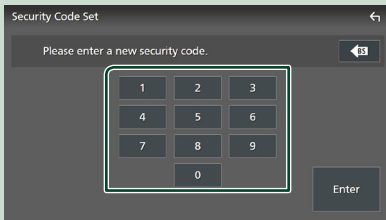

- 7 Enter the same code again and touch **Enter** .

Now, your security code is registered.

### NOTE

- Touch **BS** to delete the last entry.
- If you enter a different security code, the screen returns to step 5 (for the first code entry).
- If you have disconnected the Receiver from battery, enter the correct security code as that you have entered in step 5 and touch **Enter**. You can use your receiver.



### To change the security code:

- 1 Touch **Security Code Change** on the Security screen.
  - Security Code Set screen appears.
- 2 Enter the current registered security code and touch **Enter** .
- 3 Enter a new security code with 4 to 8 digit number and touch **Enter** .
- 4 Enter the same code again and touch **Enter** .
  - The new security code is registered.

### To clear the security code:

- 1 Touch **Security Code Cancellation** on the Security screen.
  - Security Code Set screen appears.
- 2 Enter the current registered security code and touch **Enter** .
  - The security code is cleared.

## Calendar/clock settings

- 1 Press the **HOME** /  button.
- 2 Touch .
- 3 Touch **SETUP**.
  - SETUP Menu screen appears.
- 4 Touch **System**.
  - System setting menu appears.
- 5 Set each item as follows.  
Scroll the page to show hidden items.

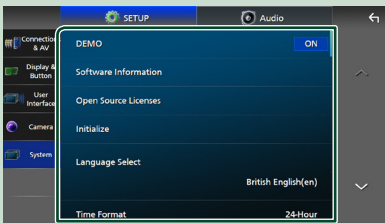

### ■ Time Format

Select the time display format.

**12-Hour / 24-Hour** (Default)

### ■ Clock

**GPS-SYNC** (Default): Synchronizes the clock time with the GPS.

**Manual**: Set the clock manually.

### ■ Time Zone

Select the time zone.

### ■ Clock Adjust

If you select **Manual** for Clock, adjust the date and time manually. **(P.8)**

## NOTE

- Please set the date and time. If they are not set, some functions may not work.

## Adjust the date and time manually

- 1 Touch **Clock** in the System setting menu.
- 2 Select **Manual**.
- 3 Touch **Time Zone** in the System setting menu.
- 4 Select the time zone.
- 5 Touch **Clock Adjust** in the System setting menu.
- 6 Adjust the date, then adjust the time.

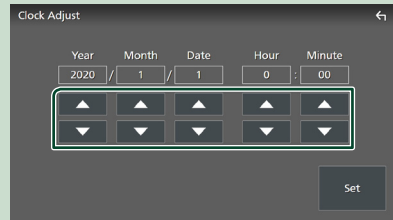

- 7 Touch **Set**.

## Adjusting the volume

You can adjust the volume (0 to 40).

Turn the knob clockwise to increase, and counter-clockwise to decrease.

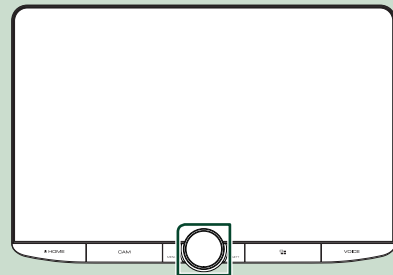



## Touch screen operations

To perform operations on the screen, you need to touch, touch and hold, flick or swipe to select an item, display a setting menu screen or change pages.

### ● Touch

Touch the screen gently to select an item on the screen.

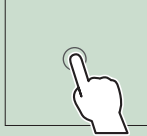

### ● Touch and hold

Touch the screen and keep your finger in place until the display changes or a message is displayed.

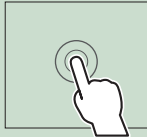

### ● Flick

Slide your finger quickly to the left or right on the screen to change the page. You can scroll a list screen by flicking up/down on the screen.

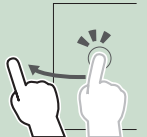

### ● Swipe

Slide your finger up or down on the screen to scroll the screen.



## HOME screen descriptions

Most functions can be performed from the HOME screen.



- 1 • Widget (P.14)
- 2 • Displays the source selection screen. (P.11)
- 3 • Displays the SETUP Menu screen. (P.51)
- 4 • Short-cut playback source icons (P.12)

## Display the HOME screen

- 1 Press the **HOME** /  button.



➤ HOME screen appears.

## Popup menu

- 1 Press the **MENU / ATT** button.
  - Popup menu appears.
- 2 Touch to display the popup menu.



The contents of the menu are as follows.

	• Displays the Screen Adjustment screen. <b>(P.51)</b>
	• Turns the display off. <b>(P.10)</b>
	• Displays the view camera screen. <b>(P.47)</b>
	• Displays the SETUP Menu screen. <b>(P.51)</b>
	• Displays the Audio screen. <b>(P.57)</b>
	• Displays the control screen of current source. Icon feature differs depending on the source. This icon is for USB source.
	• Close the popup menu.
	• Short-cut source icons: The source changes to the one you have set with a short-cut. For the short-cut setting, refer to <b>Customize Short-cut source icons (P.12)</b> .
	• Displays the Device List screen. <b>(P.36)</b>

## Turn off the screen

- 1 Select **Display OFF** on the popup menu.



### NOTE

- Touch the display to turn on the screen.
- To display the clock while the screen is off, it is necessary to set "OSD Clock" to "ON". **(P.53)**



## Source selection screen description













You can display icons of all playback sources and options on the source selection screen.



- 1 • Changes playback sources. For playback sources, see **Select the playback source (P.11)**.
- 2 • Returns to the previous screen.
- 3 • Displays the SETUP Menu screen. **(P.51)**

## Select the playback source

- 1 Press the **HOME** /  button.  
➤ HOME screen appears.
- 2 Touch .  
From the screen, you can select the following sources and functions.



	• Switches to the Digital Radio broadcast. <b>(P.31)</b>
	• Switches to the Apple CarPlay screen from the connected iPhone. <b>(P.16)</b>
	• Switches to the Android Auto screen from the connected Android smartphone. <b>(P.18)</b>
	• Displays the Hands-Free screen. <b>(P.41)</b> When neither Apple CarPlay, Android Auto, nor a Bluetooth Hands-Free phone is connected, displays Bluetooth pairing waiting dialog.*1 <b>(P.36)</b>
	• Switches to the Wireless Mirroring screen from the connected Android smartphone. <b>(P.16)</b>
	• Switches to the Radio broadcast. <b>(P.27)</b>
	• Plays a Bluetooth audio player. <b>(P.39)</b>
	• Plays an iPod/iPhone. <b>(P.24)</b>
	• Plays files on a USB device. <b>(P.21)</b>
	• Plays a device connected to the HDMI input terminal. <b>(P.50)</b>
	• Switches to an external component connected to the AV Audio input and the Video input terminal.*2 *3 <b>(P.50)</b>
	• Puts the unit in standby. <b>(P.11)</b>

\*1 When connecting as Apple CarPlay or Android Auto, it works as a phone provided in Apple CarPlay or Android Auto. If Apple CarPlay or Android Auto are connected during talking by the Bluetooth device, the current call will be continued.

\*2 You can use the **AV-IN** source when a cable from a visual source except a camera is connected to the Video input terminal, and a cable is connected to the AV Audio input terminal. **(P.82)**

\*3 Set "VIDEO IN" to "None" in Camera Assignment Settings. **(P.48)**

## Put the unit in standby

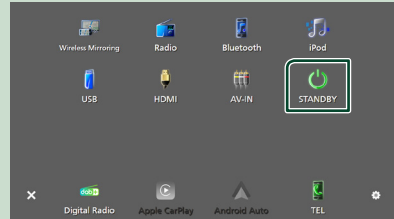

- 1 Press the **HOME** /  button.  
➤ HOME screen appears.
- 2 Touch .
- 3 Touch **STANDBY**.



## Customize Short-cut source icons

You can arrange the positions of the source icons as you like.

The 4 items placed in bottom line will appear on the bottom bar in various screens, as the short-cut playback source icons.

- 1 Press the **HOME** /  button.  
▶ HOME screen appears.
- 2 Touch .
- 3 Touch and hold the icon which you want to move in the customizing mode.
- 4 Drag the icon to the desired position.

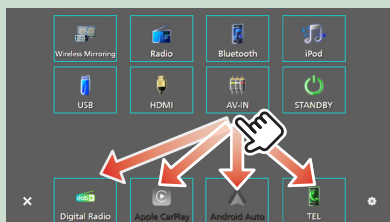

## Source control screen descriptions

There are some functions which can be performed from most screens.





1  Displays the source selection screen. (P.10)

2  Displays the SETUP Menu screen. (P.51)

3 **Short-cut source icons**  
The source changes to the one you have set with a short-cut. For the short-cut setting, refer to **Customize Short-cut source icons (P.12)**.

4 **Function panel \***  
Touch the right side of the screen to display the function panel. Touch again to close the panel.

5     
Connected Bluetooth device information.

6 **Indicator items**  
Displays the current source condition and so on.

- **ATT**: The attenuator is active.
- **DUAL**: The dual zone function is active.
- **MUTE**: The mute function is active.
- **LOUD**: The loudness control function is active.

7 **Content list \***  
Displays the track/file/station/channel list.

8 **Operation keys**  
You can operate the current source with these operation keys. The available functions are different depending on the source type.

\* For right hand drive vehicles, the left and right drawers are swapped. For how to set up the driving position, see **User Interface Setup (P.55)**.

## List screen

There are some common function keys in the list screens of most sources.  
See (P.23, 26, 40).

### Display the list screen

#### For USB/iPod:

**1** Touch **Q** or the item listed on the information area in the source control screen.

► The list screen appears.

#### For Bluetooth audio:

**1** Touch **Q**.

► The list screen appears.

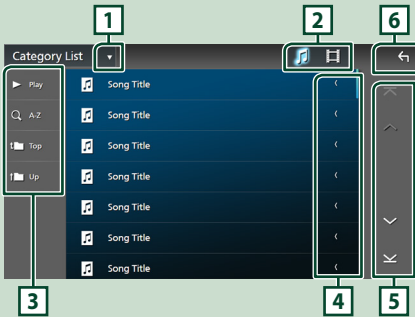

**1** ▼

Displays the list type selection window.

**2** 🎵 🎬

Displays a music/movie file list.

**3** ▶ **Play** etc.

Keys with various functions are displayed here.

- ▶ **Play**: Plays all tracks in the folder containing the current track.
- Q A-Z**: Jumps to the letter you entered (alphabetical search).
- 📁 **Top** 📁 **Up**: Moves to the upper hierarchy level.

**4** ◀ **Text scroll**

Scrolls the displayed text.

**5** ⬆ / ⬇ / ⬇ / ⬆ **Page scroll**

You can change pages to display more items by touching ⬆ / ⬇.

- ⬆ / ⬇: Displays the top or bottom page.

**6** ◀ **Return**

Returns to the previous screen.

#### NOTE

- Depending on the current source or mode, some function key may not appear.

# Widget

## Widget

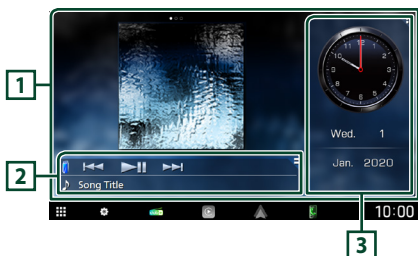

- 1 Press the **HOME** /  button.
- 2 You can change the widget or customize the widget area.



### 1 Full screen widget panel

You can change the full screen panel widget by flicking left or right on the widget panel. The widget is switched in the following sequence: Album Art, Visualizer, Photo Frame.

### 2 Flexible source widget panel

- Displays the current source information and operation keys.
- While playing an audio source, you can switch the widget panel size between 2-line and 4-line by touching the right top corner of the widget panel.
-  (USB/HDMI/AV-IN/Wireless Mirroring source only):  
Displays the source control screen.
-  (HDMI/AV-IN/Wireless Mirroring source only):  
Switches the widget panel orientation between horizontal and vertical.

### 3 Drive widget panel

You can change the drive panel widget by touching the right top corner of the widget panel. (P.14)

### Photo Frame Widget

You can display a slideshow of the image files stored in your iPhone or Android smartphone.

#### Preparation

- See **Importing Image Files (P.15)**.

## Drive Widget Panel

You can change the widget.

- 1 Press the **HOME** /  button.
- 2 Touch the right top corner of the drive widget panel.

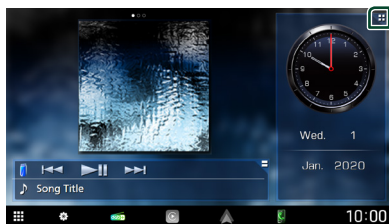

➤ The drive widget list appears.

### 3 Touch the desired widget.

You can select from the following widgets.

- Clock Widget
- Weather Widget \*1
- Compass Widget
- EQ Setting Widget
- Camera Widget

\*1 You can receive INRIX weather forecast by connecting your iPhone or Android smartphone in which the "KENWOOD Traffic Powered By INRIX" application is installed.

### ● To change the widget position

You can change the widget panel position to right or left. If the drive widget panel position is changed, the full screen widget panel position and flexible source widget panel position are also changed.

#### 1 Touch and hold the drive widget panel.

- Widget customize mode is activated.

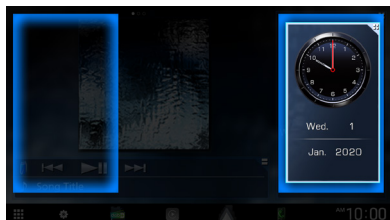

#### 2 Drag the drive widget to right or left.

### Weather Widget

You can display the weather forecast of the present location.

#### Preparation

- See **KENWOOD Traffic Powered By INRIX (P.20)**.

## Importing Image Files

You can display image files stored in your iPhone or Android smartphone by connecting your iPhone or Android smartphone in which the "KENWOOD Portal APP" application is installed to this unit.

The image files are displayed on the photo frame widget. Also, you can set an image as the wallpaper.

See **Photo Frame Widget (P.14)** and **To register an original image (P.54)**.

#### Preparation

- Install the latest version of the "KENWOOD Portal APP" application on your iPhone or Android smartphone.
  - iPhone: Search for "KENWOOD Portal APP" in the Apple App Store to find and install the most current version.
  - Android smartphone: Search for "KENWOOD Portal APP" in Google play to find and install the most current version.
- For details, see "KENWOOD Portal APP" application.

#### 1 Connect the device.

- To connect a device via Bluetooth, register it as the Bluetooth device and do the App (SPP) profile setting of the connection beforehand. See **Register the Bluetooth device (P.36)** and **Switch the connected device (P.37)**.
- Connect an iPhone using KCA-iP103 via the USB terminal. **(P.83)**

#### 2 Unlock your device.



# APPS

## Wireless Mirroring Operation

You can display the same screen of the Android smartphone on the monitor of the unit using the Wireless Mirroring function of the Android smartphone.

### Preparation

- You can use the Wireless Mirroring function with Android smartphones compatible with this function.
- This function may be called Wireless Display, Screen Mirroring, AllShare Cast, etc., depending on the manufacturer.
- The settings on the Android smartphone differ depending on the device type. For details, refer to the instruction manual supplied with your Android smartphone.
- If your Android smartphone is locked, Mirroring screen may not appear.
- If the Android smartphone is not ready for UIBC, you cannot perform touch operation.

- 1 Press the **HOME**/ button.
- 2 Touch .
- 3 Touch **Wireless Mirroring** . (P.11)
  - The App screen is displayed.
- 4 Operate your Android smartphone to activate the **Wireless Mirroring** function, then connect to this unit.
- 5 Select (“DMX9720XDS”) as the network to use.
  - When the connection is established, then the same screen displayed on the Android smartphone is displayed.

### NOTE

- Apps is discontinued when the power is turned ON/OFF or you leave the vehicle. To restart Apps, operate the Android smartphone.
- When the Apps source is displayed, you cannot register or reconnect a Bluetooth device. Switch the Apps source to another source, and then operate the Bluetooth device.

## Apple CarPlay Operation

Apple CarPlay is a smarter, safer way to use your iPhone in the car. Apple CarPlay takes the things you want to do with iPhone while driving and displays them on the screen of the product. You can get directions, make calls, send and receive messages, and listen to the music from iPhone while driving. You can also use Siri voice control to make it easier to operate iPhone.

For details about Apple CarPlay, visit <https://www.apple.com/ios/carplay/>.

### Compatible iPhone devices

You can use Apple CarPlay with the following iPhone models.

- iPhone XS Max
- iPhone XS
- iPhone XR
- iPhone X
- iPhone 8 Plus
- iPhone 8
- iPhone 7 Plus
- iPhone 7
- iPhone SE
- iPhone 6s Plus
- iPhone 6s

## Connecting an iPhone

### Wired connection

- 1 Connect your iPhone using KCA-iP103 via the **USB terminal**. (P.83)

When an iPhone compatible with Apple CarPlay is connected to the USB terminal, the Bluetooth Hands-Free phone currently connected is disconnected. If another Bluetooth Hands-Free phone is being used, disconnection will occur after ending the call.

- 2 Unlock your iPhone.



## Wireless connection

You can select the iPhone registered in **Device List** and use it as the Apple CarPlay device.

See **Register the Bluetooth device (P.36)**.

### NOTE

- Turn on the Bluetooth function and Wi-Fi function of an iPhone.
- If two or more iPhone have been registered, select the iPhone to be used as the **Apple CarPlay** source. **(P.17)**
- It is necessary to connect the GPS antenna in order to use a wireless Apple CarPlay.
- When the Wi-Fi connection becomes unavailable, the HOME screen is displayed.
- You cannot use Apple CarPlay if the function is turned off by operating the iPhone at functional setup.

## To switch the Current Screen to the Apple CarPlay Screen When Connecting Your iPhone

- Touch **Apple CarPlay** icon on the source selection screen. **(P.11)**
- Touch the following connection message if the message appears.

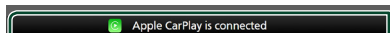

### NOTE

- The connection message appears when;
  - The iPhone you used previously is connected again.
  - The screen other than HOME and the source selection screen is displayed.
- The connection message is displayed for about 5 seconds.

## Select an Apple CarPlay device

If two or more iPhone compatible with Apple CarPlay have been registered, select the iPhone to be used as the Apple CarPlay source. See **Switch the connected device (P.37)**.

## Operation keys and available Apps on the home screen of Apple CarPlay

You can use the Apps of the connected iPhone. The items displayed and the language used on the screen differ among the connected devices.

To enter the Apple CarPlay mode, touch **Apple CarPlay** icon on the source selection screen. **(P.11)**

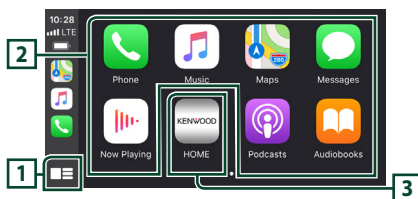

### 1 \*

- Displays the home screen of Apple CarPlay.
- Touch and hold to activate Siri.

### 2 Application keys

Starts the application.

### 3 HOME

Exits the Apple CarPlay screen and displays the Home screen.

\*The icon design may change depending on the iOS version.

## To exit the Apple CarPlay screen

- 1 Press the **HOME** /  button.

## Use Siri

You can activate Siri.

- 1 Press the **VOICE** button.

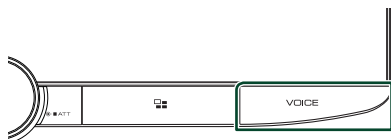

- 2 Talk to Siri.

### To deactivate

- 1 Press the **VOICE** button.

## Switch to the Apple CarPlay screen while listening to another source

- 1 Press the  button.

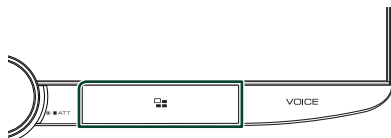

### NOTE

- When listening to another source with the Apple CarPlay screen displayed, playing music in the Apple CarPlay mode will switch the current source to the Apple CarPlay source.

## Android Auto™ Operation

Android Auto enables you to use the functions of your Android smartphone convenient for driving. You can easily access route guidance, make calls, listen to music, and access convenient functions on the Android smartphone while driving.

For details about Android Auto, visit <https://www.android.com/auto/> and <https://support.google.com/androidauto>.

### Compatible Android smartphones

You can use Android Auto with Android smartphones of Android version 5.0 or later. For Wi-Fi connection, Android 8.0 or later.

### NOTE

- Android Auto may not be available on all devices and may not be available in all countries or regions.

### ● About the placement of smartphone

Install the smartphone connected as Android Auto device in the place where it can receive the GPS signals.

When using Google Assistant, install the smartphone in the place where the smartphone easily catch a voice by the microphone.

### NOTE

- Do not put the smartphone in a spot exposed to direct sunlight or near an air blowing out port of an air conditioner. The placement of the smartphone in such places can lead to malfunction or damage of your smartphone.
- Do not leave the smartphone in the vehicle.

## Connect Android smartphone

### Wired connection

#### 1 Connect an Android smartphone via the USB terminal. (P.84)

To use the Hands-Free function, connect the Android smartphone via Bluetooth.

When an Android smartphone compatible with Android Auto is connected to the USB terminal, the device is connected via Bluetooth automatically, and the Bluetooth Hands-Free phone currently connected is disconnected.

#### 2 Unlock your Android smartphone.

#### 3 Press the **HOME** / button.

#### 4 Touch .

#### 5 Touch **Android Auto**. (P.11)

### Wireless connection

You can select the Android smartphone registered in **Device List** and use it as the Android Auto device. See **Register the Bluetooth device** (P.36).

#### 1 Press the **HOME** / button.

#### 2 Touch .

#### 3 Touch **Android Auto**. (P.11)

### NOTE

- Turn on the Bluetooth function and Wi-Fi function of Android smartphone.
- If two or more Android smartphones have been registered, select the Android smartphone to be used as the Android Auto source. (P.19)
- To change the password for wireless connection manually, refer to **Reset Android Auto Wireless Connection** (P.52).
- When the Wi-Fi connection becomes unavailable, the HOME screen is displayed.

## Select an Android smartphone

If two or more Android smartphones have been registered, select the Android smartphone to be used as the Android Auto source. See **Switch the connected device** (P.37).

## Operation keys and available Apps on the Android Auto screen

You can perform the operations of the Apps of the connected Android smartphone.

The items displayed on the screen differ among the connected Android smartphones.

To enter the Android Auto mode, touch the **Android Auto** icon on the source selection screen. (P.11)

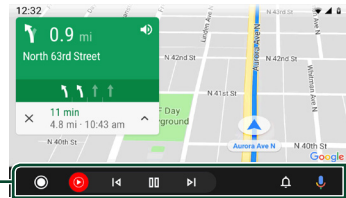

#### 1 Navigation bar

Starts the application or displays information.

### To exit the Android Auto screen

#### 1 Press the **HOME** / button.

## Using voice control

- 1 Press the **VOICE** button.

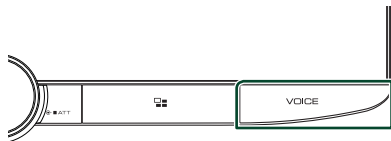

- 2 Start speaking.

### NOTE

- When you press and hold the **VOICE** button while inputting voice, you can start over from the beginning.

### To cancel

- 1 Press the **VOICE** button.

## Switch to the Android Auto screen while listening to another source

- 1 Press the  button.

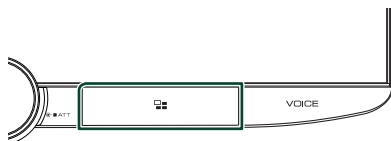

### NOTE

- When listening to another source with the Android Auto screen displayed, playing music in the Android Auto mode will switch the current source to the Android Auto source.

## KENWOOD Traffic Powered By INRIX

You can receive INRIX weather forecast by connecting your iPhone or Android smartphone in which the "KENWOOD Traffic Powered By INRIX" application is installed to this unit.

### Preparation

- Install the latest version of the KENWOOD Traffic Powered By INRIX application on your iPhone or Android smartphone.
  - iPhone: Search for "KENWOOD Traffic Powered By INRIX" in the Apple App Store to find and install the most current version.
  - Android smartphone: Search for "KENWOOD Traffic Powered By INRIX" in Google play to find and install the most current version.
- For details, see "KENWOOD Traffic Powered By INRIX" application.

- 1 **Connect the device.**

- To connect a device via Bluetooth, register it as the Bluetooth device and do the App (SPP) profile setting of the connection beforehand. See **Register the Bluetooth device (P.36)** and **Switch the connected device (P.37)**.
- Connect an iPhone using KCA-iP103 via the USB terminal. **(P.83)**

### NOTE

- When an Apple CarPlay is connected, you can receive INRIX traffic information and weather forecast.

# USB

## Connecting a USB device

- 1 Connect the USB device with the USB cable. (P.83)

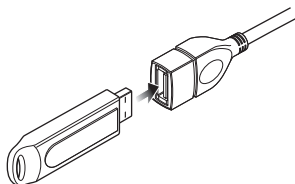

- 2 Press the HOME / ⏻ button.
- 3 Touch .
- 4 Touch **USB**. (P.11)

### Disconnect the USB device

- 1 Press the HOME / ⏻ button.
- 2 Touch a source other than **USB**.
- 3 Detach the USB device.

### Usable USB device

You can use a mass-storage-class USB device with this unit.

The word "USB device" appearing in this manual indicates a flash memory device.

#### ● About the file system

The file system should be the one of the following.

- FAT16    • FAT32    • exFAT    • NTFS

#### NOTE

- Install the USB device in the place where it will not affect safe driving.
- You cannot connect a USB device via a USB hub and Multi Card Reader.
- Take backups of the audio files used with this unit. The files can be erased depending on the operating conditions of the USB device. We shall have no compensation for any damage arising from any erased data.

## USB Basic Operation

Most functions can be controlled from the source control screen and playback screen.

#### NOTE

- Set the remote controller mode switch to AUD mode before starting operation, see **Switch the operation mode (P.69)**.

#### Control screen

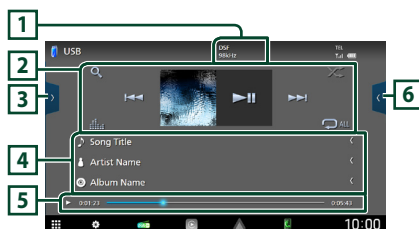

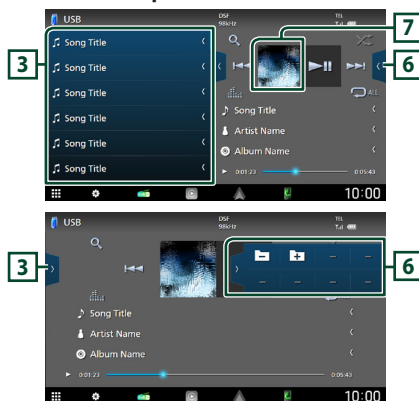

#### Open the drawer



#### 1 CODEC

When a high-resolution source is played, its format information is displayed.

#### 2 Operation keys

-  : Searches track/file. For details on search operation, see **Search Operation (P.23)**.
-   : Searches the previous/next track/file.

Touch and hold to fast forward or fast backward. (It will be cancelled automatically after about 50 seconds.)

- **▶||** : Plays or pauses.
- **▢▢▢▢** : Displays the Graphic Equalizer screen. **(P.59)**
- **↺** : Repeats the current track/folder. Each time you touch the key, repeat modes are switched in the following sequence: File repeat ( **↺** ), Folder repeat ( **↺** ), Repeat all ( **↺** )
- **⌂** : Randomly plays all tracks in the current folder. Each time you touch the key, random modes are switched in the following sequence: Folder random ( **⌂** ), Random off ( **⌂** )

**3 Content list**

- Touch the left side of the screen to display the Content list. Touch again to close the list.
- Displays the playing list. When you touch a track/file name on the list, playback will start.

**4 Track information**

Displays the information on the current file. Only a file name and a folder name are displayed if there is no tag information.

**5 Play mode indicator/Playing time**

- **▶, ▶▶, etc.**: Current play mode indicator. Meanings of individual icons are as follows: **▶** (play), **▶▶** (fast forward), **◀◀** (fast backward), **||** (pause).
- For confirmation of current playing position. You can drag the circle left or right to change the playing position.



**6 Function panel**

Touch the right side of the screen to display the function panel. Touch again to close the panel.

- **◀ +** : Searches for the previous/next folder.

**7 Artwork**

The jacket of the currently playing file is displayed.

Video screen



**8 File search area (Video file only)**

Touch to search for the next/previous file.

**9 Key display area (Video file only)**

Touch to display the control screen.

## Search Operation

You can search music or video files by the following operations.

1 Touch **Q**.

2 Touch **▼**.



3 Select a list type.

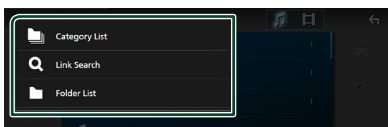



### NOTE

- For operations on the list screen, see *List screen (P.13)*.

## Category search

You can search for a file by selecting a category.

1 Touch **Category List**.

2 Select whether you search audio files  or video files .

3 Touch the desired category.

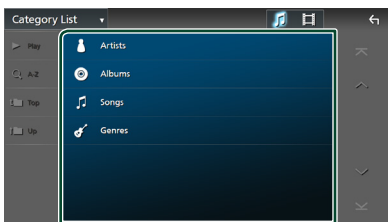

► The list corresponding to your selection appears.

4 Touch to select the desired item in the list. Repeat this step until you find the desired file.

## Link search (Audio file only)

You can search for a file of the same artist/album/genre as that in the current track.

1 Touch **Link Search**.

2 Touch the desired tag type. You can select from artists, albums and genres.

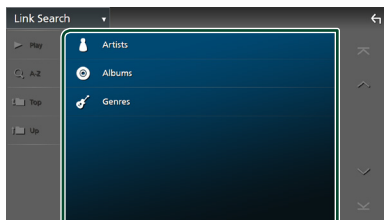

► The list corresponding to your selection appears.

3 Touch the desired item in the content list.

## Folder search

You can search for a file according to hierarchy.

1 Touch **Folder List**.

2 Touch the desired folder.

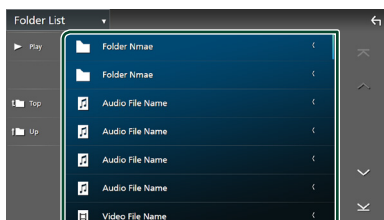

When you touch a folder its contents are displayed.

3 Touch to select your desired item in the list. Repeat this step until you find the desired file.

# iPod/iPhone

## Preparation

### Connectable iPod/iPhone

The following models can be connected to this unit.

Made for

- iPhone XS Max
- iPhone XS
- iPhone XR
- iPhone X
- iPhone 8 Plus
- iPhone 8
- iPhone 7 Plus
- iPhone 7
- iPhone SE
- iPhone 6s Plus
- iPhone 6s
- iPod touch (6th generation)

#### NOTE

- Latest compatible list of iPod/iPhone. For details, see [www.kenwood.com/cs/ce/ipod/](http://www.kenwood.com/cs/ce/ipod/).
- By connecting your iPod/iPhone to this unit with the iPod connection cable KCA-iP103 (optional accessory), you can supply power to your iPod/iPhone as well as charge it while playing music. Note that the power of this unit must be held on.
- If you restart playback after connecting the iPod, the music that has been played by the iPod is played first.

### Connect iPod/iPhone

#### Wired connection

##### Preparation

- Connect an iPod/iPhone with the KCA-iP103 (optional accessory) while Apple CarPlay is not connected.
- With an iPhone compatible with Apple CarPlay, turn off Apple CarPlay by operating the iPhone at functional setup before connecting iPhone. For details of the setup method, contact the manufacturer of the terminal.
- Plug the iPod/iPhone into the USB terminal with the KCA-iP103 (optional accessory).
- Only one iPod/iPhone can be connected.

**1** Connect the iPod/iPhone using the KCA-iP103. (P.83)

**2** Press the **HOME** /  button.

**3** Touch .

**4** Touch **iPod**. (P.11)

● **To disconnect the iPod/iPhone connected with the cable:**

**1** Detach the iPod/iPhone.

#### Bluetooth connection

Pair the iPhone through Bluetooth.

##### Preparation

- To connect an iPhone via Bluetooth, register it as a Bluetooth device and do the profile setting for the connection beforehand. See **Register the Bluetooth device (P.36)** and **Switch the connected device (P.37)**.
- Connect an iPhone via Bluetooth while Apple CarPlay and an iPod/iPhone are not connected via USB.
- With an iPhone compatible with Apple CarPlay, turn off Apple CarPlay by operating the iPhone at functional setup before connecting iPhone. For details of the setup method, contact the manufacturer of the terminal.

● **Select the method of making connections for outputting sound from the iPod source**

**1** Press the **HOME** /  button.

**2** Touch .

**3** Touch **SETUP**.

➤ SETUP Menu screen appears.

**4** Touch **Connections & AV**.

➤ Connections & AV setting menu appears.

**5** Touch **iPod Bluetooth Connection**.

**Bluetooth** (Default): Output sound using a Bluetooth device.

**Bluetooth+HDMI**: Output sound using an HDMI device and perform music selection, etc. using a Bluetooth device.



## iPod/iPhone Basic Operation

### NOTE

- Set the remote controller mode switch to **AUD** mode before starting operation, see **Switch the operation mode (P.69)**.

### Control screen

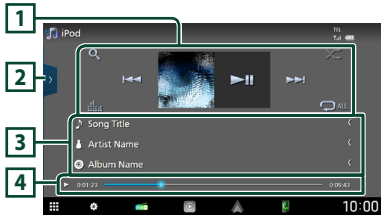

### Open the drawer

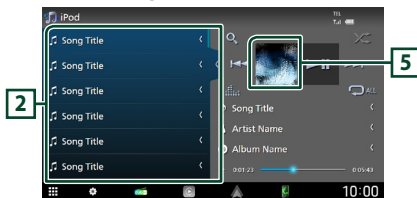

### 1 Operation keys

- Q** : Searches for a track/file. For details on search operation, see **Search Operation (P.26)**.
- ⏮ ⏭** : Searches for the previous/next track/file.  
Touch and hold to fast forward or fast backward. (It will be cancelled automatically after about 50 seconds.)
- ▶ ||** : Plays or pauses.
- 📊** : Displays the Graphic Equalizer screen. **(P.59)**
- 🔄** : Repeats the current track/album. Each time you touch the key, repeat modes are switched in the following sequence:  
Song repeat (🔄), All songs repeat (🔄All), Repeat off (🔄)
- 🎲** : Randomly plays all tracks in the current album. Each time you touch the key, random modes are switched in the following sequence:  
Song random (🎲), Random off (🎲)

### 2 Content list

- Touch the left side of the screen to display the Content list. Touch again to close the list.
- Displays the playing list. When you touch a track/file name on the list, playback will start.

### NOTE

- The Content list is not displayed unless you select a file from the category list and play it. To use the category list, see **Search Operation (P.26)**.

### 3 Track information

- Displays the information on the current file.
- Touch to display the category list screen. See **Category search (P.26)**.

### 4 Play mode indicator/Playing time

- ▶, ▶▶, etc.:** Current play mode indicator  
Meanings of individual icons are as follows:  
▶ (play), ▶▶ (fast forward), ◀◀ (fast backward), || (pause).
- For confirmation of current playing position. You can drag the circle left or right to change the playing position.



### 5 Artwork

The jacket of the currently being played file is displayed.

## Search Operation

You can search music files by the following operations.

1 Touch **Q**.

2 Touch **▼**.



3 Select a list type.

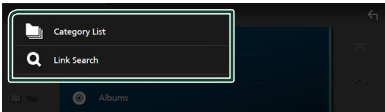

### NOTE

- For operations on the list screen, see **List screen (P.13)**.

## Category search

You can search for a file by selecting a category.

1 Touch **Category List**.

2 Touch the desired category.

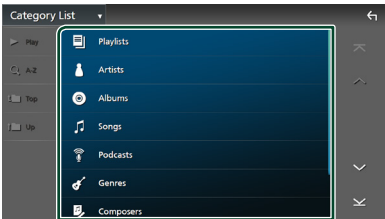

- The list corresponding to your selection appears.

3 Touch to select the desired item in the list. Repeat this step until you find the desired file.

## Link search

You can search for a file of the same artist/album/genre/composer as that in the current track.

1 Touch **Link Search**.

2 Touch the desired tag type. You can select from artists, albums, genres and composers.

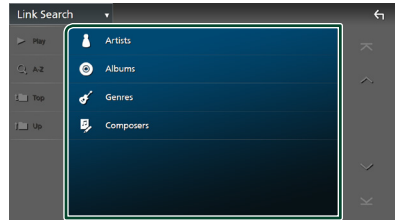

- The list corresponding to your selection appears.

3 Touch the desired item in the content list.

# Radio

## Radio Basic Operation

Most functions can be controlled from the source control screen.

To listen to the Radio source, touch **Radio** icon on the source selection screen. (P.11)

### NOTE

- Set the remote control mode switch to **AUD** mode before starting operation, see **Switch the operation mode (P.69)**.

### Control screen

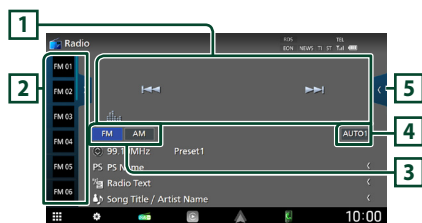

### Open the drawer

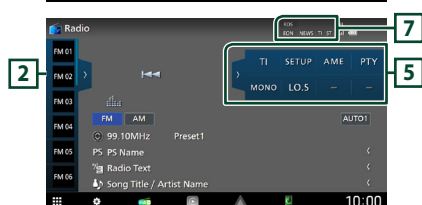
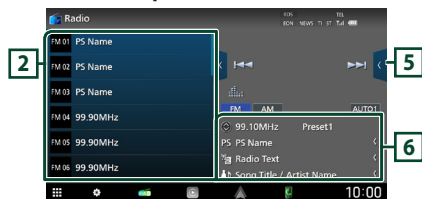

### 1 Operation keys

- ◀▶ : Tunes in a station. The method of switching frequencies can be changed (see **4** Seek mode).
- : Displays the Graphic Equalizer screen. (P.59)

### 2 Preset list

- Touching allows you to change the display size.
- Recalls the memorized station.
- When touched for 2 seconds, stores the currently being received station in the memory.

### 3 Band keys

Switches bands (between FM and AM).

### 4 Seek mode

Touch to switch seek mode in the following sequence: **AUTO1**, **AUTO2**, **MANUAL**.

- AUTO1** : Tunes in a station with good reception automatically.
- AUTO2** : Tunes in the memorized stations one after another.
- MANUAL** : Switches to the next frequency manually.

### 5 Function panel

Touch the right side of the screen to display the function panel. Touch again to close the panel.

- TI** (FM only) : Selects the traffic information mode. For details, see **Traffic Information (P.29)**.
- SETUP** (FM only) : Displays the Radio SETUP screen. For details, see **Radio SETUP (P.30)**.
- AME** : Presets stations automatically. For details, see **Auto memory (P.28)**.
- PTY** (FM only) : Searches for a program by program type. For details, see **Search by program type (P.29)**.
- MONO** (FM only) : Selects the Monaural reception mode.
- LO.S** (FM only) : Turns the Local Seek function on or off.

### 6 Information display

- Displays the information on the current station:  
Frequency  
Touching  allows you to switch between Content A and Content B.  
Content A: PS name, Radio Text, Title & Artist  
Content B: PTY Genre, Radio Text plus  
**Preset#**: Preset number

### 7 Indicator Items

- **RDS**: Indicates the state of the Radio Data System station when the AF function is on.  
White: Radio Data System is being received.  
Orange: Radio Data System is not being received.
- **EON**: The Radio Data System station is sending EON.
- **NEWS**: News bulletin interruption is in progress.
- **TI**: Indicates the reception state of traffic information.  
White: TP is being received.  
Orange: TP is not being received.
- **ST**: A stereo broadcast is being received.

## Memory Operation

### Auto memory

You can store stations with good reception in the memory automatically.

#### 1 Touch desired band key.

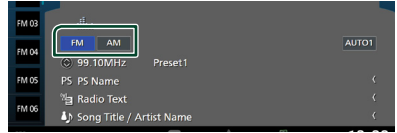

#### 2 Touch on the right side of the screen. Touch **AME**.



#### 3 Touch **Yes**.

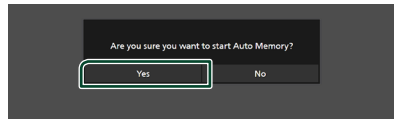

> Auto memory starts.

### Manual memory

You can store the currently being received station in the memory.

#### 1 Select the station you wish to store in the memory.

#### 2 Touch **FM#** (#:1-15) or **AM#** (#:1-5) in which you want to store the station for 2 seconds until a beep sounds.

## Selecting Operation

### Preset select

You can list and select memorized stations.

- 1 Touch **>** on the left side of the screen. Select a station from the list.

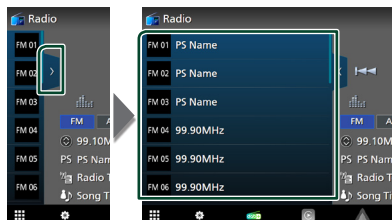

### Search by program type (FM only)

You can tune in the station broadcasting the specified type of program when listening to FM.

- 1 Touch **<** on the right side of the screen. Touch **PTY**.



► PTY Search screen appears.

- 2 Select a program type from the list.
- 3 Touch **Search**.

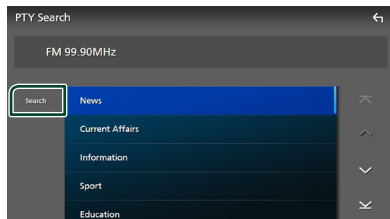

You can search for the station broadcasting the selected type of program.

## Traffic Information (FM only)

You can listen to and watch traffic information automatically when a traffic bulletin starts. However, this feature requires a Radio Broadcast Data System that includes TI information.

- 1 Touch **<** on the right side of the screen. Touch **TI**.

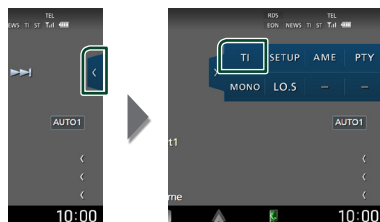

► Traffic information mode is set.

### When the traffic bulletin starts

The Traffic Information screen appears automatically.

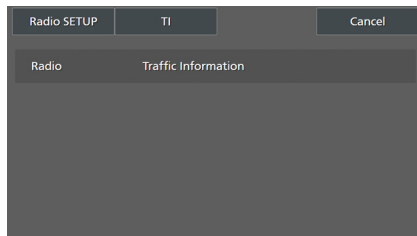

#### NOTE

- It is necessary to turn on the Traffic Information function in order to allow the Traffic Information screen to appear automatically.
- The volume setting made during reception of traffic information is automatically memorized. When the traffic information is received next time, this unit recalls the volume setting automatically.
- To cancel Traffic Information: Touch **Cancel**.

## Radio SETUP

You can set tuner related parameters.

- 1 Touch **⏪** on the right side of the screen. Touch **SETUP**.

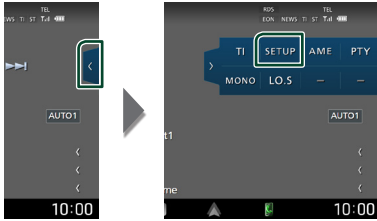

➤ Radio SETUP screen appears.

- 2 Set each function as follows.

■ **NEWS**

Sets a news bulletin interrupt time. Default is "OFF".

■ **AF**

When station reception is poor, automatically switches to the station that is broadcasting the same program over the same Radio Data System network. Default is "ON".

■ **Regional**

Sets whether to switch to the station only in the specific region using the "AF" control. Default is "ON".

■ **Auto TP Seek**

When traffic information station reception is poor, automatically searches for a station that can be received better. Default is "ON".

■ **Language Select**

Selects a display language for the PTY function.

# Digital Radio

## Digital Radio Basic Operation

Most functions can be controlled from the source control screen.

To listen to Digital Radio source, touch **Digital Radio** icon on the source selection screen. (P.11)

### NOTE

- Set the remote controller mode switch to AUD mode before starting operation, see **Switch the operation mode (P.69)**.

### Control screen

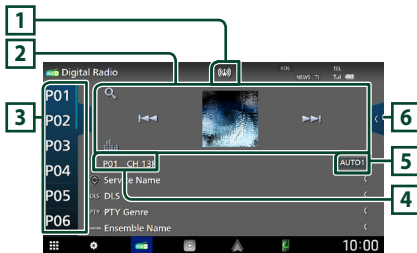

### Open the drawer

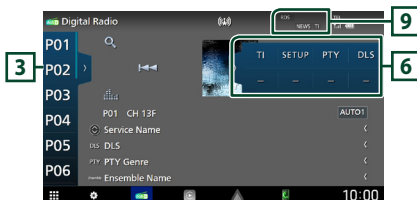

### 1 Indicator display

Displays the received signal strength.

### 2 Operation keys

- Q** : Displays the Service List screen. For details on search operation, see **Service search (P.33)**.
- ◀▶** : Tunes in a ensemble, service, and component. The seek mode switching can be changed. (see **5 Seek mode**).
- 📊** : Displays the Graphic Equalizer screen. (P.59)

### 3 Preset list

- Touching **◀▶** allows you to change the display size.
- Recalls the memorized service.
- When touched for 2 seconds, stores the currently being received service in the memory.

### 4 Indicator display

**P#**: Preset number

**CH#**: Channel display

### 5 Seek mode

Touch to switch seek modes in the following sequence: **AUTO1**, **AUTO2**, **MANUAL**.

- AUTO1** : Tunes in a ensemble with good reception automatically.
- AUTO2** : Tunes in the memorized ensemble one after another.
- MANUAL** : Switches to the next ensemble manually.

### 6 Function panel

Touch the right side of the screen to display the function panel. Touch again to close the panel.

- TI** : Selects the traffic information mode. For details, see **Traffic Information (P.33)**.
- SETUP** : Displays the Digital Radio SETUP screen. For details, see **Digital Radio SETUP (P.34)**.
- PTY** : Searches for a program by program type. For details, see **Search by program type (P.32)**.
- DLS** : Display the Dynamic Label Segment screen.

### 7 Artwork

The picture data is displayed if available from current content.

**8 Information display**

Displays the information on the current station:  
Service Name

Touching  allows you to switch between Content A, Content B and Content C.

Content A: DLS, PTY Genre

Content B: Song Title, Artist Name, Ensemble name

Content C: Now Playing, Next Program, Audio Quality

Touch to switch between the Control and Information screen.



**9 Indicator Items**

- **RDS**: Radio Data System is being received.
- **NEWS**: News bulletin interruption is in progress.
- **TI**: Indicates the reception state of traffic information.  
White: TP is being received.  
Orange: TP is not being received.

**Storing Service in Preset Memory**

You can store the current receiving service in the memory.

- 1 Select a service you wish to store in memory.
- 2 Touch  on the left side of the screen.

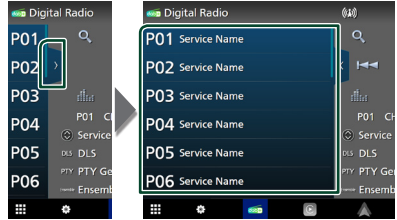

- 3 Touch **P#** (#:1-15) in which you want to store the station for 2 seconds until a beep sounds.

**Selecting Operation**

 **Search by program type**

You can tune in the station broadcasting the specified type of program when listening to Digital Radio.

- 1 Touch  on the right side of the screen. Touch **PTY**.

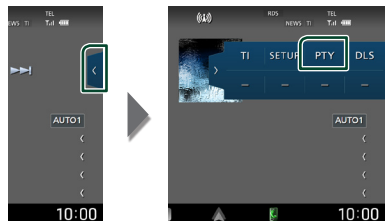

> PTY Search screen appears.

- 2 Select a program type from the list.



### 3 Touch Search.

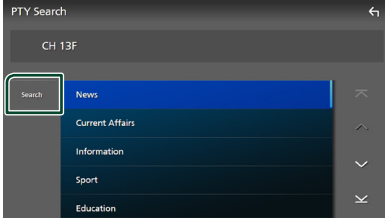

You can search for the station broadcasting the selected type of program.

### Service search

You can select a service from a list of all services received.

#### 1 Touch Q.

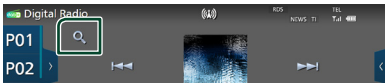

#### 2 Select the desired content from the list.

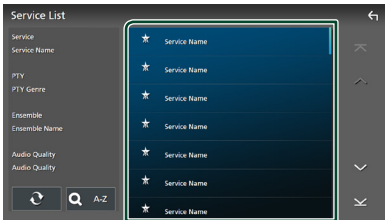

Touch and hold to find the latest service list.



Displays the keyboard screen.

Jump to the letter you entered (alphabet search).

## Traffic Information

You can listen to and watch traffic information automatically when a traffic bulletin starts. However, this feature requires a Digital Radio that includes TI information.

#### 1 Touch on the right side of the screen. Touch TI.

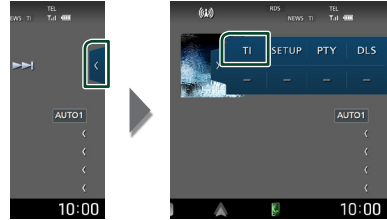

➤ Traffic information mode is set.

#### When the traffic bulletin starts

The Traffic Information screen appears automatically.

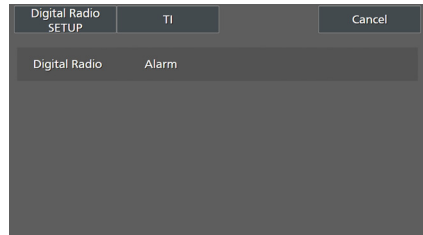

#### NOTE

- It is necessary to turn on the Traffic Information function in order to allow the Traffic Information screen to appear automatically.
- The volume setting made during reception of traffic information is automatically memorized. When the traffic information is received next time, this unit recalls the volume setting automatically.
- To cancel Traffic Information: Touch **Cancel**.

## Digital Radio SETUP

You can set Digital Radio related parameters.

- 1 Touch  on the right side of the screen. Touch **SETUP**.

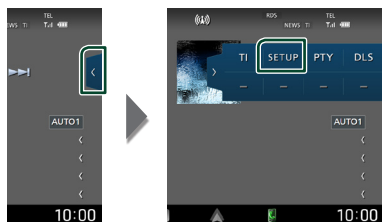

➤ Digital Radio SETUP screen appears.

- 2 Set each function as follows.

### ■ Priority

If the same service is provided by Digital Radio during Radio Data System reception, automatically switches to Digital Radio. If the same service is provided by Radio Data System when reception of the service being provided by Digital Radio becomes poor, automatically switches to Radio Data System.

### ■ PTY Watch

If the service of the set program type begins with the ensemble being received, switches from any source to Digital Radio for service reception.

### ■ Announcement Select

Switches to the set Announcement service. For details, see **Announcement setup (P.34)**.

### ■ Antenna Power

Sets power supply to the Digital Radio antenna. Set to "ON" when the Digital Radio antenna in use is equipped with a booster. Default is "ON".

### ■ Related Service

When you select ON, the unit switches to a related service (if exists) when a Digital Radio service network is not available. Default is "OFF".

### ■ Language Select

Selects a display language for the PTY function.

## Announcement setup

When the service for which ON is selected starts, switches from any source to Announcement to receive it.

- 1 Touch **Announcement Select** on the Digital Radio SETUP screen.

➤ The Announcement Select screen appears.

- 2 Touch each Announcement list and set on or off.

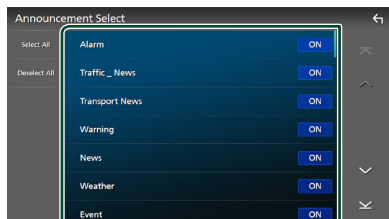

### ■ Select All

Turn on all announcements.

### ■ Deselect All

Turn off all announcements.

### NOTE

- The volume setting during reception of Announcement service is automatically stored. The next time the Announcement service is received, this unit recalls the volume setting automatically.

# Bluetooth Control

Using the Bluetooth function allows you to use various functions such as listening to the audio file and making/receiving a call.

## Information for using Bluetooth® devices



Bluetooth is a short-range wireless radio communication technology for mobile devices such as smartphones/cell-phones, portable PCs, and other devices.

Bluetooth devices can be connected without cables and communication with each other.

### NOTE

- While driving, do not perform complicated operations such as dialing numbers, using the phonebook, etc. When you perform these operations, stop your car in a safe place.
- Some Bluetooth devices may not be connected to this unit depending on the Bluetooth version of the device.
- This unit may not work for some Bluetooth devices.
- Connecting conditions may vary depending on your environment.
- Some Bluetooth devices are disconnected when this unit is turned off.
- The Bluetooth devices cannot be used while using Apple CarPlay.
- The Bluetooth currently connected with other device is disconnected when an iPhone compatible with Apple CarPlay is connected.

## About the smartphone/cell-phone and Bluetooth audio player

This unit conforms to the following Bluetooth specifications:

### Version

Bluetooth Ver. 5.0

### Profiles

#### Smartphone/cell-phone:

HFP (V1.7) (Hands Free Profile)

SPP (Serial Port Profile)

PBAP (Phonebook Access Profile)

### Audio player:

A2DP (Advanced Audio Distribution Profile)

AVRCP (V1.6) (Audio/Video Remote Control Profile)

### Sound codec

LDAC, SBC, AAC

### NOTE

- The units supporting the Bluetooth function have been certified for conformity with the Bluetooth Standard according to the procedure prescribed by Bluetooth SIG.
- However, it may be impossible for such units to communicate with your smartphone/cell-phone depending on its type.



## Register the Bluetooth device

It is necessary to register the Bluetooth audio player or smartphone/cell-phone in this unit before using the Bluetooth function.

You can register up to 10 Bluetooth devices.

### NOTE

- Up to 10 Bluetooth devices can be registered. If an attempt is made to register the 11th Bluetooth device, the Bluetooth device connected on the earliest date will be deleted to register the 11th one.
- This unit is compatible with the Apple Easy Pairing function. When an iPod touch or iPhone connected via USB terminal previously is connected again, an authentication dialog appears. Performing operation for authentication on this unit, or iPod touch or iPhone registers the smartphone as a Bluetooth device.

- 1 Press the **HOME** /  button.
- 2 Touch .
- 3 Touch **SETUP**.  
➤ **SETUP** Menu screen appears.
- 4 Touch **Connections & AV**.

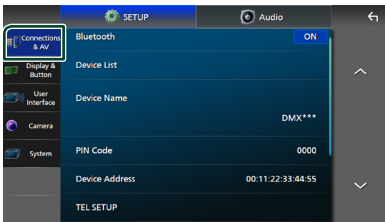

- 5 Touch **Device List**.
- 6 Select a device type.

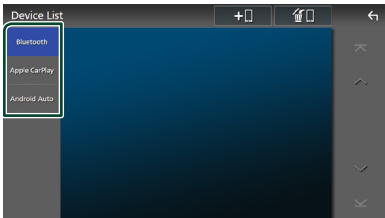

### ■ Bluetooth

To connect as Bluetooth Hands-Free and Bluetooth audio source.

### ■ Apple CarPlay

To connect as Apple CarPlay source.

### ■ Android Auto

To connect as Android Auto source.

- 7 Touch .  
➤ Bluetooth pairing waiting dialog appears.

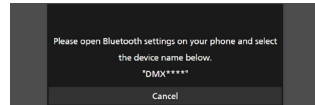

### NOTE

- If an Apple CarPlay device is currently connected, the Apple CarPlay device will be disconnected.
- When neither Apple CarPlay, Android Auto, nor a Bluetooth Hands-Free phone is connected, pressing and holding the **VOICE** button displays Bluetooth pairing waiting dialog.

- 8 Search for the unit ("DMX9720XDS") from your smartphone/cell-phone.  
Complete steps 8 to 10 within 30 seconds.
- 9 Operate your smartphone/cell-phone according to the displayed messages.

- Confirm the request both on the smartphone/cell-phone.

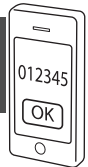
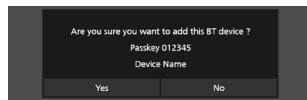

- Input the PIN Code in your smartphone/cell-phone.

PIN Code is set to "0000" as the default.

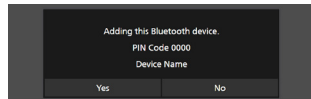

**10 Touch Yes.**

When data transmission and connection have completed, the Bluetooth connection icon appears on the screen.

**NOTE**

- When registering the iPhone that is available for Apple CarPlay wirelessly, a confirmation message appears.
  - Yes:** Displays the Apple CarPlay screen for wireless connection.
  - No:** Apple CarPlay is not connected. When using Apple CarPlay, see **Select an Apple CarPlay device (P.17)**.

**Switch the connected device**

If two or more Bluetooth devices have been registered, select the device to be used.

**1 Touch Device List in the Connections & AV setting menu.****2 Select the device type.****Bluetooth**

To connect as Bluetooth Hands-Free and Bluetooth audio source.

**Apple CarPlay**

To connect as Apple CarPlay source.

**Android Auto**

To connect as Android Auto source.

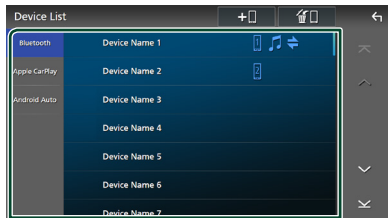
**3 Touch the name of the device you want to connect.****NOTE**

- If the icon is lighted, it means that the unit will use that device.
- If you touch the device name with the icon on the list of Apple CarPlay devices, it will be disconnected.
- You can quickly display the Device List screen by touching  in the popup menu. **(P.10)**

**To switch the connected device to a Bluetooth device****1 Touch Bluetooth on the Device List screen.**

> Bluetooth device list appears.

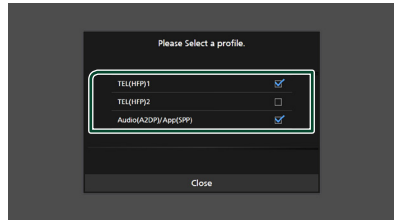
**2 Touch the name of the Bluetooth device you want to connect.****3 Set each profile as follows.****TEL (HFP) 1, TEL (HFP) 2**

Select when the device is connected with the unit as Hands-Free phone 1 or 2.

**Audio (A2DP)/App (SPP)**

Select to use as an audio player or to interwork with an application installed in a smartphone.

**4 Touch Close.****To delete the registered device**

You can delete the device that is registered as Bluetooth source or Apple CarPlay source.

When you delete a Bluetooth device which supports Android Auto, the device is also deleted from the Android Auto device list.

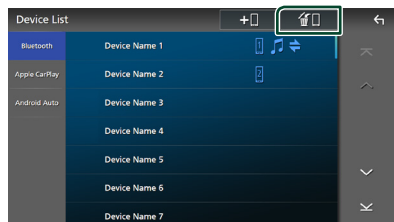
**1 Touch  on the Device List screen.**

## Bluetooth Control

### 2 Touch the device name to check.

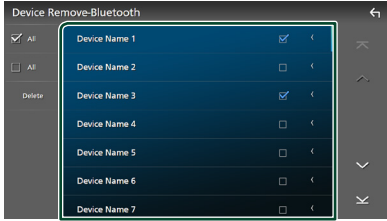

#### ■ All

Selects all Bluetooth devices.

#### ■ All

Clears all check marks.

### NOTE

- You cannot select a device currently connected.
- When you select Android Auto tab,  is not displayed.

### 3 Touch Delete.

➤ Confirmation message appears.

### 4 Touch Yes.

➤ All the selected device(s) is deleted.

## Bluetooth Setup

### NOTE

- The Bluetooth Setup is disabled while using Apple CarPlay.

### 1 Press the HOME/⏻ button.

### 2 Touch .

### 3 Touch SETUP.

➤ SETUP Menu screen appears.

### 4 Touch Connections & AV.

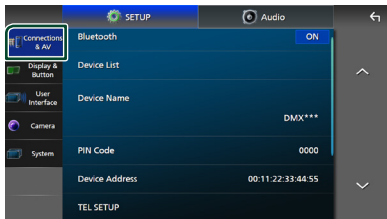

➤ Connections & AV setting menu appears.

### 5 Touch **Bluetooth** and set to **ON**.

See the following section for each setting.

- Change the PIN Code (**P.38**)
- Change the device name (**P.38**)
- Change the settings for Hands-Free function, see **Hands-Free Setup (P.46)**.

### NOTE

- For the other setting items on this screen, see **Connections & AV Setup (P.51)**.

### Change the device name

#### 1 Touch **Device Name** in the Connections & AV setting menu.

➤ Change Device Name screen appears.

#### 2 Touch and hold .

#### 3 Input the device name.

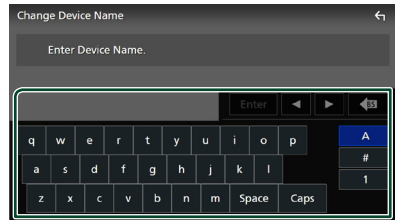

#### 4 Touch **Enter**.

### Change the PIN Code

#### 1 Touch **PIN Code** in the Connections & AV setting menu.

➤ Change PIN Code screen appears.

#### 2 Touch and hold .

#### 3 Input the PIN Code.

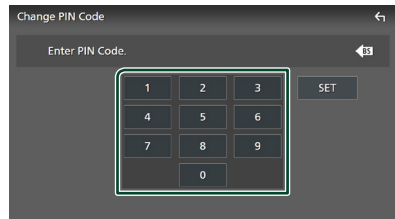

#### 4 Touch **SET**.

## Playing the Bluetooth Audio Device

Most function can be controlled from the source control screen.

To select Bluetooth source, touch **Bluetooth** icon on the source selection screen. (P.11)

### NOTE

- The Bluetooth audio source is disabled while using Apple CarPlay.
- The Bluetooth audio source is disabled when the device set as Audio(A2DP)/App(SPP) is using Android Auto.

## Bluetooth basic operation

### Control screen

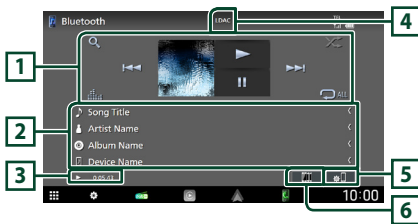

### 1 Operation keys \*

- **Q** : Searches for a file. See **File search (P.40)**.
- **◀◀ ▶▶** : Searches for the previous/next content.  
Touch and hold to fast forward or fast backward. (It will be cancelled automatically after about 50 seconds.)
- **▶** : Plays.
- **||** : Pauses.
- **EQ** : Displays the Graphic Equalizer screen. (P.59)
- **🔄** : Repeats the current track/folder. Each time you touch the key, repeat modes are switched in the following sequence:  
File repeat (🔄), Folder repeat (🔄), All songs repeat (🔄ALL), Repeat off (🔄)
- **🎲** : Randomly plays all tracks in the current folder. Each time you touch the key, random modes are switched in the following sequence:  
Folder random (🎲), All random (🎲ALL), Random off (🎲)

### 2 Information display \*

- Displays the name of track information.
- Connected device name.

### 3 Play mode indicator/Playing time

▶, ||: Current play mode indicator

Meanings of individual icons are as follows:

- ▶ (play), ▶▶ (fast forward), ◀◀ (fast backward), || (pause), ■ (stop).

### 4 CODEC

When an LDAC-compatible device is connected, "LDAC" is displayed.

### 5

Displays the Connections & AV setting menu.

(P.38)

### 6 KENWOOD Music Mix

Bluetooth audio devices can be switched easily to play music. See **KENWOOD Music Mix (P.40)**.

\* These items appear only when the audio player which supports AVRCP profile is connected.

### NOTE

- The operation keys, indications and information displayed on the screen differ depending on the connected device.
- If the operation keys do not appear, operate from the player.
- Depending on your smartphone/cell-phone or audio player, sound may be heard and controlled but text information may not appear.
- If the volume is too low, raise it on your smartphone/cell-phone or audio player.
- It is recommended that you change the playback quality from "priority on sound quality" to "priority on stable connection" in the settings of your LDAC-compatible device so that the intermittent sound problem is less likely to occur.





## KENWOOD Music Mix

Up to 5 Bluetooth audio device can be connected and switched easily to play music.



### 1 Touch .

➤ A list of registered devices is displayed.

### 2 Touch of device name you want to connect.

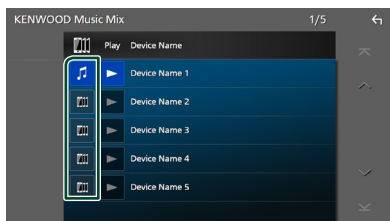
- Touching  displays the Device List screen. (P.37)
- Touching  on the left of the connected device (   ) disconnects this device.





-  : Device used normally.
-  : Device used for KENWOOD Music Mix

### 3 Touch (White/dark blue background) on the left of the name of the device to be played.

The background changes from dark to light blue and starts playback.



-  (Gray) : Not connected.
-  (White/dark blue background) : Connected.
-  (White/light blue background) : During playback.

### 4 Touch .

#### NOTE

- If a connected Bluetooth audio device is operated to play music, connections are switched.
- When a Bluetooth source is switched to another one, its settings are deleted and the connection is restored to the connection before source switching.
- You cannot select an Android smartphone connected as an Android Auto device.

## File search

### 1 Touch .

### 2 Touch the desired file or folder.

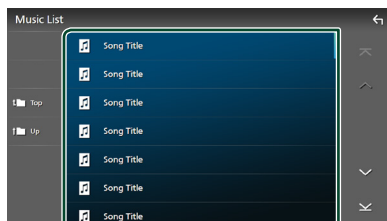

When you touch a folder its contents are displayed.

### 3 Touch the desired item in the content list.

➤ Playback starts.

#### NOTE

- For operations in the list screen, see **List screen (P.13)**.



## Using the Hands-Free Unit

You can use the telephone function by connecting the Bluetooth telephone to this unit.

### NOTE

- While Apple CarPlay or Android Auto is connected, the Bluetooth Hands-Free function and two Bluetooth devices connections cannot be used. Only the Apple CarPlay or Android Auto Hands-Free function can be used.

## Make a call

1 Press the **HOME** / **⏻** button.

2 Touch .

3 Touch **TEL**.

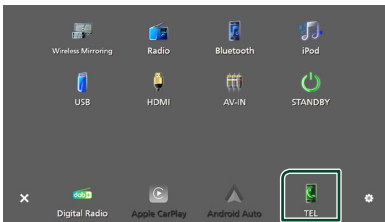





➤ Hands-Free screen appears.

### NOTE

- If your smartphone/cell-phone supports PBAP, you can display the phonebook and call lists onto the touch panel screen when the smartphone/cell-phone is connected.
  - Phonebook: up to 1000 entries
  - Up to 50 entries including dialed calls, received calls, and missed calls



## 4 Select a dialing method.



- : Call using call records
- : Call using the phonebook
- : Call using the preset number
- : Call by entering a phone number

### ● Select the smartphone/cell-phone to use

When you connect two smartphones/cell-phones

1) Touch   to select the phone you want to use.

### ● Bluetooth Setup

1) Touch .  
Connections & AV setting menu appears. **(P.38)**

### ● Voice Recognition

1) Touch . **(P.43)**

### NOTE



- Status icons such as battery and antenna icons may differ from those displayed on the smartphone/cell-phone.
- Setting the smartphone/cell-phone in the private mode can disable the Hands-Free function.

Call using call records

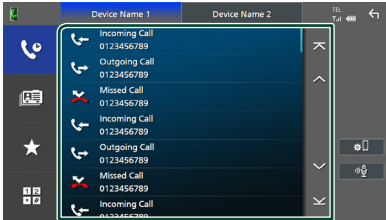
- 1 Touch .
- 2 Select the phone number from the list.



Call using the phonebook

- 1 Touch .
- 2 Touch  A-Z.
- 3 Select the initial.

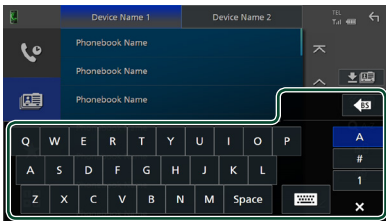

- Characters with no corresponding name will not appear.
- A first character with an accent character such as “ü” can be searched for with a non-accent character “u”. A character with an accent character in a sentence cannot be searched for.

- 4 Select the person you want to call from the list.

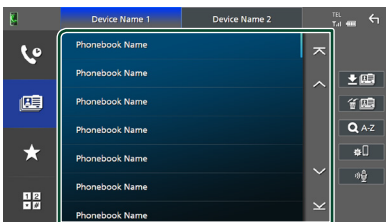

- 5 Select the phone number from the list.

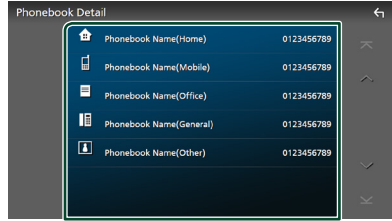

NOTE

- You can sort the phone numbers in the list by last name or first name. For details, see **Hands-Free Setup (P.46)**.
- When Russian is selected in “Language Select” (P.56), you can switch between English keyboard and Russian keyboard.
- When Hebrew is selected in “Language Select” (P.56), you can switch between English keyboard and Hebrew keyboard.
- You can search with 3 initial letters on the English keyboard and 1 initial letter on the Russian / Hebrew keyboard.

Call using the preset number

- 1 Touch .
- 2 Touch the name or phone number.

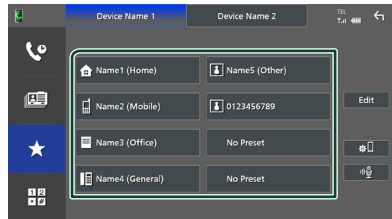

## Call by entering a phone number

- 1 Touch .
- 2 Enter a phone number with number keys.

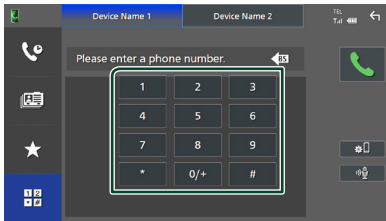

- 3 Touch .

## Voice Recognition

You can access the voice recognition function of the smartphone/cell-phone connected to this unit. You can search the smartphone/cell-phone phonebook by voice. (The functionality depends on the smartphone/cell-phone.)

- 1 Press the **VOICE** button.

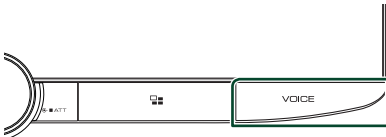



- Voice Recognition screen appears.

- 2 Start speaking.

### NOTE

- You can use the voice recognition function by touching  on the Hands-Free screen.
- You can use the voice recognition function for the connected smartphone/cell-phone if you selected **TEL (HFP) 1** or **TEL (HFP) 2** for HFP when registered.

## Receive a call

- 1 Touch  to answer a phone call or  to reject an incoming call.

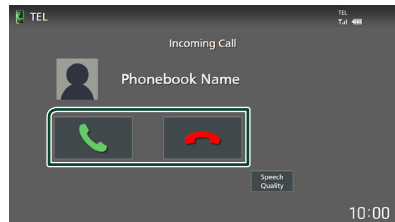

### NOTE

- When shifting the gear to the reverse (R) position and monitoring the picture from the rear view camera, this screen does not appear even if a call comes in.
- The portrait registered in the phonebook is displayed while making/receiving calls and during a call.
- If you edit the phonebook on the connected device side after downloading the phonebook, the portrait may not be displayed depending on the edited content. It is recommended that you download the phonebook whenever you edit it.
- The image quality of a displayed portrait may depend on a connected device.

## To end call

- 1 While talking, touch .

## Operations during a call



### ● Adjust the volume of your voice

- 1) Touch **Speech Quality**.
- 2) Touch ◀ or ▶ for **Microphone Level**.

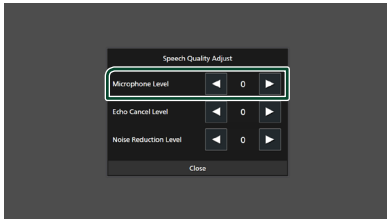

### ● Adjust the receiver volume

Turn the volume knob clockwise to increase, and counter-clockwise to decrease.

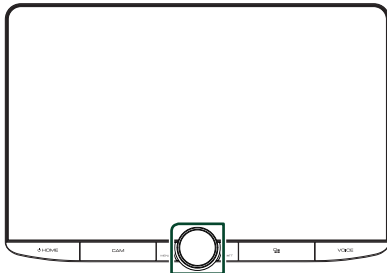

### ● Mute your voice

Touch  to mute or not to mute your voice.

### ● Output the dial tone

Touch **DTMF** to display the tone input screen. You can send tones by touching desired keys on the screen.

### ● Switching between speaking voice output destinations

Touching  /  each time switches speaking voice output destinations between the smartphone/cell-phone and the speaker.

### ● Call-waiting

When you receive a new call while talking on the phone, you can answer the newly received call by touching . The current call is put on hold.

Each time you touch , the caller will change to the other one.

When you touch , the current call will end to be switched to the call waiting on hold.

## Phone number preset

You can register frequently used phone numbers in this unit.

1 Touch .

2 Touch **Edit**.



3 Select where to preset.

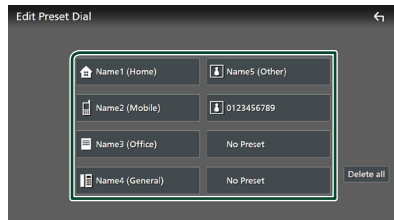

### ■ Delete all

To delete all preset numbers, touch **Delete all** and then touch **Yes** on the confirmation screen.

#### 4 Select how to preset.

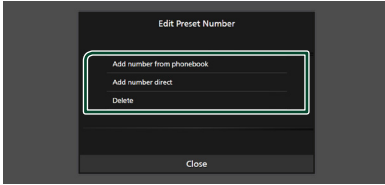

##### ■ Add number from phonebook

Select the number to preset from the phonebook.

##### ■ Add number direct

Enter the telephone number directly and touch **SET**.

##### ■ Delete

To delete a preset number, touch **Delete** and then touch **OK** on the confirmation screen.

#### Phonebook transfer

You can transfer phonebook data from your Bluetooth smartphone using PBAP.

1 Touch .

2 Touch .



► Phonebook data transfer starts.

#### NOTE

- If the Phonebook contains more than 1000 entries, only 1000 entries are transferred. The 1001st and later entries are not transferred.
- If no Phonebook has been downloaded, touching **Download Phonebook Now** will start downloading the Phonebook.
- The portrait registered in the phonebook is displayed while making/receiving calls and during a call.  
If you edit the phonebook on the connected device side after downloading the phonebook, the portrait may not be displayed depending on the edited content. It is recommended that you download the phonebook whenever you edit it.

#### Phonebook deletion

1 Touch .

2 Touch the name to check.

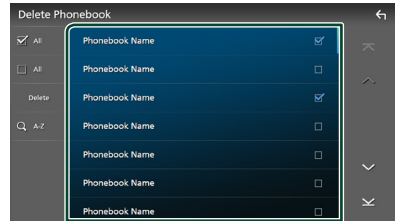

■  **All**

Checks all boxes.

■  **All**

Clears all check marks.



3 Touch **Delete**.

► Confirmation message appears.

4 Touch **Yes**.

## Hands-Free Setup

You can make various settings for the Hands-Free function.

- 1 Press the **HOME** /  button.
- 2 Touch .
- 3 Touch **SETUP**.
  - ▶ SETUP Menu screen appears.
- 4 Touch **Connections & AV**.

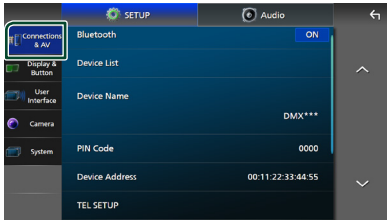

▶ Connections & AV setting menu appears.

- 5 Touch **TEL SETUP**.
  - ▶ TEL SETUP screen appears.
- 6 Set each function as follows.

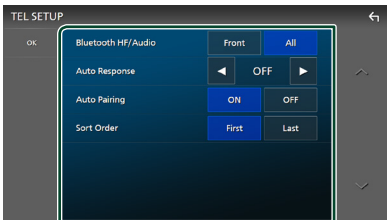

### Bluetooth HF/Audio

Select the speakers to output the sound from the smartphone/cell-phone (such as phone call voice and ringing tone) and Bluetooth audio player.

**Front**: Outputs sound from the front speakers.

**All** (Default): Outputs sound from all speakers.

### Auto Response \*

Set the automatic response time to pick-up an incoming call.

**OFF** (Default): Turns off the Automatic response function.

**1/5/10/15/20/25/30**: Sets the ringing time (second).

### Auto Pairing

When set to "ON", the Apple Auto Pairing function is turned on to automatically register the iPod touch or iPhone connected to this unit.

**ON** (Default): Turns on the Apple Auto Pairing function.

**OFF**: Turns off the Apple Auto Pairing function.

### Sort Order

Set how to sort the data in the smartphone/cell-phone phonebook.

**First** (Default): Sorts data by the first name.

**Last**: Sorts data by the last name.

\* Either the auto response time set on this unit or the time set on the smartphone/cell-phone, whichever is shorter takes effect.

### 7 Touch **OK**.

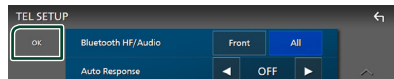

# Other External Components

## View Camera

### NOTE

- To connect a camera, see **Connecting the camera (P.84)**.
- To use a rear view camera, a REVERSE lead connection is required. **(P.80)**
- If **Rear Camera Interruption** is active the camera screen is displayed when you shift the gear to the reverse (R) position.
- The camera whose view was displayed last is kept and the same camera view will be displayed the next time. If its assignment setting is changed, the rear camera view is displayed.
- Rear/front camera interruption screen is not kept as the camera screen which will be displayed the next time.

### Display the camera screen

#### 1 Press the **MENU / ATT** button.

- Popup menu appears.

#### 2 Touch **Camera**.



- View camera screen appears.

#### 3 Adjust each item as follows.

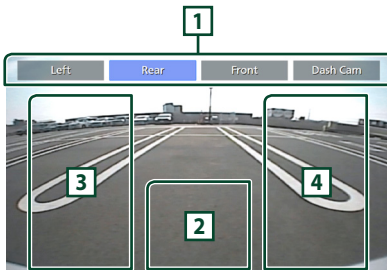

#### 1 Camera Switching Keys \*1

Touch to switch the view camera. It is necessary to set "Camera Assignment Settings" beforehand except "Rear". See **To set up the camera assignment settings (P.48)**.

#### 2 Camera off

Touch to exit the camera screen.

#### 3 Switching the Guideline \*2

Touching each time turns on or off the guideline.

#### 4 Switching the Angle \*2

Touching each time changes camera angles.

\*1 When two or more cameras of rear, front, dashboard, left, and right are connected with this unit.

\*2 Only when the rear camera screen is displayed and CMOS-3xx series is connected with this unit as the rear camera.

### Camera Setup

#### 1 Press the **HOME / ⏻** button.

#### 2 Touch .

#### 3 Touch **SETUP**.

- SETUP Menu screen appears.

#### 4 Touch **Camera**.

- Camera setting menu appears.

#### 5 Set each item as follows.

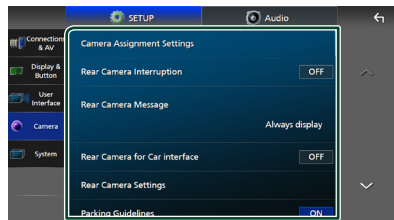

#### Camera Assignment Settings

Set up the camera assignment. See **To set up the camera assignment settings (P.48)**.

#### Rear Camera Interruption

**ON** (Default): Displays the picture from the rear view camera when you shift the gear to the reverse (R) position.

**OFF**: Select this when no camera is connected.

## Other External Components

### ■ Rear Camera Message \*1

**Always display** (Default): Always displays the caution message on the rear camera interruption screen.

**Clear after 5 seconds**: Displays the caution message for about 5 seconds on the rear camera interruption screen.

### ■ Rear Camera for Car interface

**ON**: Select when you connected an external system unit. Neither keys nor titles are displayed.

**OFF** (Default): Select when you connected a rear camera.

### ■ Rear Camera Settings \*2

Adjusts the CMOS-3xx series with ID 1 ("Rear Camera") set. For details, see the instruction manual of your camera.

### ■ Parking Guidelines

You can display parking guidelines to enable easier parking when you shift the gear to the reverse (R) position.

Default is "ON".

### ■ Guidelines SETUP

If you select **ON** for **Parking Guidelines**, you can adjust the parking guidelines. See **To adjust the parking guidelines** (P.49).

### ■ Front Camera Settings \*3

Adjusts the CMOS-3xx series with ID 2 ("Front Camera") set. For details, see the instruction manual of your camera.

### ■ Front Camera Interruption \*4

**10 sec / 15 sec** (Default) / **20 sec**: The front camera screen is displayed when return the gear from the reverse (R) position.

**OFF**: Cancel.

\*1 To use the function, it is necessary to set **Rear Camera Interruption** to **ON**.

\*2 When CMOS-3xx series is connected with this unit.

\*3 To use the function, it is necessary to connect CMOS-3xx series and to set **Camera Assignment Settings** to **Front**. (P.48)

\*4 To use the function, it is necessary to set **Rear Camera Interruption** to **ON**, to set **Rear Camera for Car interface** to **OFF**, and to set **Camera Assignment Settings** to **Front**. (P.48)

## ■ To set up the camera assignment settings

1 Touch **Camera Assignment Settings** in the Camera setting menu. (P.47)

2 Select the item to set up.

### ■ REAR VIEW CAMERA

Set the camera assignment from view camera connected to Rear view camera input terminal.

### ■ FRONT VIEW CAMERA / DASH CAM

Set the camera assignment from view camera connected to Front view camera / Dashboard camera input terminal.

### ■ 3rd VIEW CAMERA

Set the camera assignment from view camera connected to 3rd view camera input terminal.

### ■ VIDEO IN

Set the camera assignment from view camera connected to Video input terminal.

3 Select the view camera to set up.

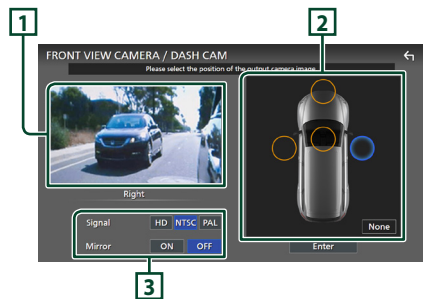

1 Picture from view camera

Displays the picture from the view camera connected to the input terminal to be set. (P.84)

2 Camera Position

Assign each position to the view camera connected to the selected input terminal. Front \*1 / Left \*1 / Right \*1 / Dashboard Camera \*1 / Rear \*2 / **None** \*1

3 Picture quality settings

Switch the picture quality setting.

**Signal** \*3: "HD" / "NTSC" (Default) / "PAL"

**Mirror** \*4: "ON" / "OFF" (Default)



- \*1 Except the **REAR VIEW CAMERA** setting screen.
- \*2 The **REAR VIEW CAMERA** setting screen only.
- \*3 The **REAR VIEW CAMERA** and **FRONT VIEW CAMERA / DASH CAM** setting screens only.
- \*4 The **FRONT VIEW CAMERA / DASH CAM** and **3rd VIEW CAMERA** setting screens only.

#### 4 Touch Enter.

##### NOTE

- The screen shot above is for the **FRONT VIEW CAMERA / DASH CAM** setting screen. It may be different from the ones for **REAR VIEW CAMERA**, **3rd VIEW CAMERA** and **VIDEO IN**.
- The Dashboard Camera can be selected when it is connected. (P.84)

#### To adjust the parking guidelines

##### NOTE

- Install the rear view camera in the appropriate position according to the instruction manual supplied with the rear view camera.
- When adjusting the parking guidelines, make sure to apply the parking brake to prevent the car from moving.

#### 1 Touch **Parking Guidelines** in the Camera screen and set to **ON**. (P.47)

#### 2 Touch **Guidelines SETUP** on the Camera screen.

#### 3 Adjust the parking guidelines by selecting the mark.

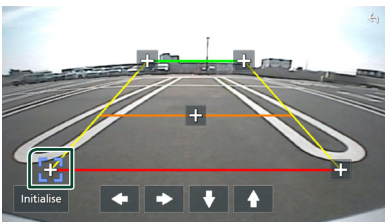

#### 4 Adjusting the position of the selected mark.

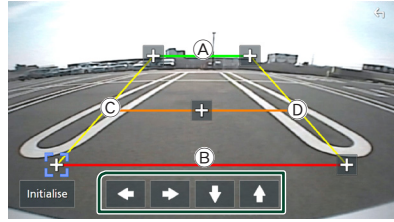

Make sure that lines (A) and (B) are horizontally parallel, and that lines (C) and (D) are of the same length.

##### NOTE

- Touch **Initialise** and then touch **Yes** to set all the  marks to their initial default position.

### Use Dashboard Camera

A Dashboard Camera, DRV-N520 (optional accessory), connected to this unit lets you play video-recorded data and so on.

For details, see the instruction manual of the Dashboard Camera DRV-N520 (optional accessory).

##### NOTE

- To connect a dashboard camera, see **Connecting the camera (P.84)**.
- To use the dashboard camera function, it is necessary to set "Camera Assignment Settings" to "Dashboard Camera". (P.48)

## Other External Components

### Display the dashboard camera screen

- 1 Press the **MENU / ATT** button.
  - Popup menu appears.
- 2 Touch **Camera**.

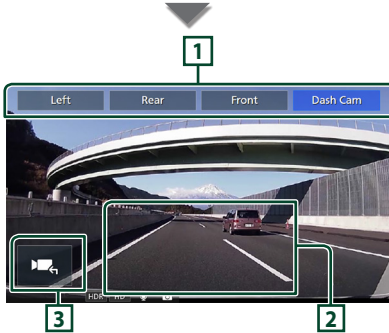

#### 1 Camera Switching Keys

Touch to switch the view camera. It is necessary to set "Camera Assignment Settings" beforehand except "Rear". See **To set up the camera assignment settings (P.48)**.

#### 2 Camera off

Touch to exit the camera screen.

#### 3 Key display

Touch to display the dashboard camera control keys.

## External audio/video players (AV-IN)

- 1 Connect an external component to the AV Audio input and the Video input terminal. (P.82)
- 2 Select **AV-IN** as the source. (P.11)
- 3 Turn on the connected component and start playing the source.



### NOTE

- To select the AV-IN source, it is necessary to set "VIDEO IN" to "None" in **Camera Assignment Settings**. (P.48)

## HDMI source

- 1 Connect your smartphone to the HDMI input terminal. (P.82)  
Use HDMI cable KCA-HD100 (optional accessory).
- 2 Select **HDMI** as the source. (P.11)
- 3 Start an application or playback on your smartphone.

# Setup

- 1 Press the **HOME** /  button.
- 2 Touch .
- 3 Touch **SETUP**.

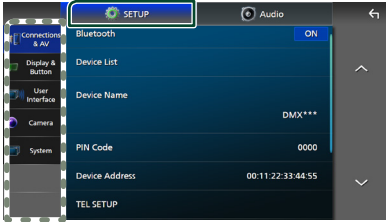

See the following section for each setting.

- Set up connections and AV (*P.51*)
- Set up display and button (*P.53*)
- Set up the user interface (*P.55*)
- Set up camera (*P.47*)
- Set up systems (*P.56*)

## Monitor Screen Setup

You can adjust the image quality of video, menu screen, etc.

- 1 Press the **MENU** / **ATT** button.
  - Pop up menu appears.
- 2 Touch **Screen Adjustment**.

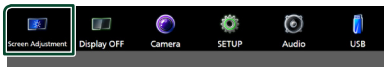

➤ Screen Adjustment screen appears.

- 3 Adjust each setting as follows.



### ■ Backlight / Contrast / Black / Brightness / Colour / Tint

Adjust each setting.

### ■ Aspect

Select a screen mode.

**Full** : Changes the aspect ratio of video and displays video fully on the screen.

**Normal** : Displays video at the ratio of 4:3.

**Auto** :



USB device: Displays video fully (vertically or horizontally) with no ratio change.

### NOTE

- Settings to adjust vary depending on the current source.

## Connections & AV Setup

You can set connections and AV parameters.

- 1 Press the **HOME** /  button.
- 2 Touch .
- 3 Touch **SETUP**.
  - SETUP Menu screen appears.
- 4 Touch **Connections & AV**.
  - Connections & AV setting menu appears.
- 5 Set each parameter as follows.

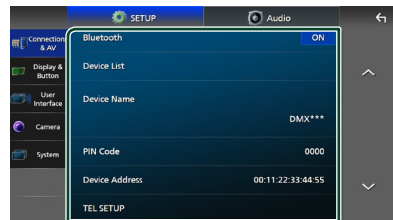

### ■ Bluetooth

Turns the Bluetooth function on or off.

### ■ Device List

Select the connected device to be used. (*P.37*)

## Setup

### ■ Device Name

If you select **ON** for **Bluetooth**, you can change the Bluetooth device name.

See **Change the device name (P.38)**.

### ■ PIN Code

If you select **ON** for **Bluetooth**, you can change the PIN code.

See **Change the PIN Code (P.38)**.

### ■ Device address

Display the Bluetooth device address.

### ■ TEL SETUP

You can make various settings for the Hands-Free function.

See **Hands-Free Setup (P.46)**.

### ■ Wi-Fi SETUP

You can change the device name and display the device address, password. See **Change the device name (P.52)**.

### ■ Speech Quality Adjust

Adjust the speech quality.

**Microphone Level** : Adjust the level of microphone gain. Default is "0".

**Echo Cancel Level** : Adjust the level of echo cancellation. Default is "0".

**Noise Reduction Level** : Reduce the noise generated in the surrounding environment without changing the microphone volume. Use this function when the voice of caller is not clear. Default is "0".

### ■ iPod Bluetooth Connection

See **Select the method of making connections for outputting sound from the iPod source (P.24)**.

### ■ AV-OUT

You can select an AV source to be output from the AV OUTPUT port.

OFF, iPod, USB, or AV-IN

- You cannot select AV-IN if the Video input terminal is used for camera.
- You cannot select iPod if it is connected via Bluetooth or Apple CarPlay is connected.
- If you select iPod as the main source, you cannot select USB as the AV output source.
- If you select USB as the main source, you cannot select iPod as the AV output source.

- If you select HDMI as the main source, files with sampling rates higher than 96 kHz in USB selected as the AV output source are skipped.
- If you select Bluetooth audio, Radio, Digital Radio, Wireless Mirroring, Apple CarPlay or Android Auto as the main source, you cannot select USB or iPod as the AV output source.

### ■ Reset Android Auto Wireless Connection

You can change the password for wireless Android Auto.

The system of the unit is rebooted after selecting **YES**.

## Change the device name

### 1 Touch **Device Name** in the Connections & AV setting menu.

or

Touch **Wi-Fi SETUP** and then touch **Device Name**.

➤ Change Device Name screen appears.

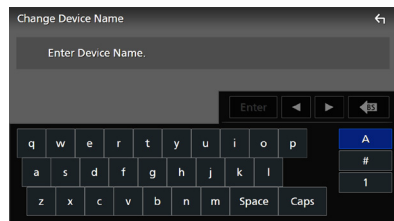

### 2 Touch and hold **BS**.

### 3 Input the device name.



### 4 Touch **Enter**.

## Display & Button Setup

- 1 Press the **HOME** /  button.
- 2 Touch .
- 3 Touch **SETUP**.
  - SETUP Menu screen appears.
- 4 Touch **Display & Button**.
  - Display & Button setting menu appears.
- 5 Set each parameter as follows.

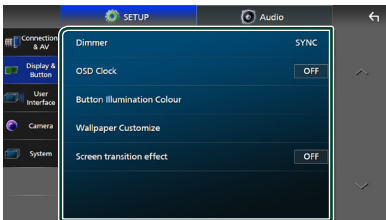

### ■ Dimmer

Select the dimmer mode.

**OFF**: Does not dim the display and buttons.

**ON**: Dims the display and buttons.

**SYNC** (Default): Turns the dimmer function on or off when the vehicle light control switch is turned on or off.

### ■ OSD Clock

Select if you want to display the clock while the screen is off, or while watching video files on USB, etc.

"ON" (Default)/"OFF"

### ■ Button Illumination Colour

You can set the button illumination color.

(P.53)

### ■ Wallpaper Customize

You can change the wallpaper image or color. (P.54)

### ■ Screen transition effect

Select whether to use the screen transition effect when the source control screen is switched to the Home screen.

"ON" (Default)/"OFF"

## ■ Customizing the button color

You can set the button illumination color.

- 1 Touch **Button Illumination Colour** in the Display & Button setting menu.
- 2 Touch the desired color.



### ■ Variable

You can set the button color to continuously scan through the color spectrum.

### ■ User

You can set the color created with the RGB color mixer.

- 3 Touch .

## To register an original color

You can register your original color.

- 1 Touch **User** on the Button Illumination Colour screen.
- 2 Use - and + to adjust each color value.

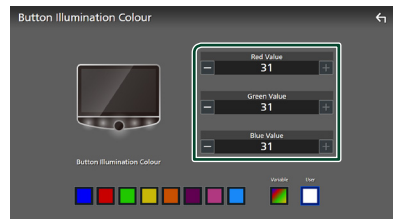

- 3 Touch .

## NOTE

- You can create a color based on a preset color. Touch the preset color instead of **User**, and adjust the color value.

## Setup

### Change the wallpaper image or color

- 1 Touch **Wallpaper Customize** in the Display & Button setting menu.
- 2 Select an image.

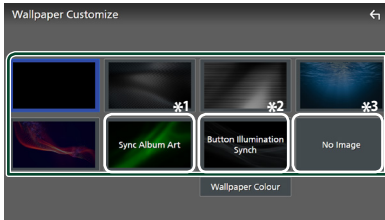

- \*1 The album art currently being displayed is used as a wallpaper.
- \*2 Select a wallpaper color in advance.
- \*3 Select an original image in advance.

### To select wallpaper color

- 1 Touch **Wallpaper Colour** on the Wallpaper Customize screen.
- 2 Select a wallpaper color.

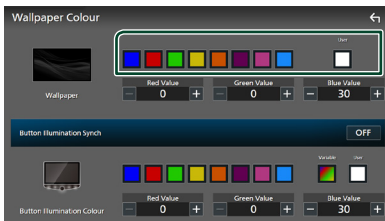

#### User

You can set the color created with the RGB color mixer. For how to create an original color, see **To register an original color (P.53)**.

#### Button Illumination Synch \*1

The color you have selected at **Button Illumination Colour** can be set. If you adjust the color value with the following RGB color mixer, the adjusted color will be applied to the wallpaper and the button illumination.

For how to set the button illumination color and create an original color, see **Customizing the button color (P.53)**.

"ON"/"OFF" (default)

\*1 When **Button Illumination Colour** is "Variable", this option is fixed to OFF.

- 3 Touch  .

### To register an original image

With "KENWOOD Portal APP" application installed on your iPhone or Android smartphone, you can upload image files to this unit and set an image as the wallpaper image. See **Importing Image Files (P.15)**.

## User Interface Setup

You can setup user interface parameters.

- 1 Press the **HOME**/**⏻** button.
- 2 Touch **⚙️**.
- 3 Touch **SETUP**.
  - SETUP Menu screen appears.
- 4 Touch **User Interface**.
  - User Interface setting menu appears.
- 5 Set each parameter as follows.

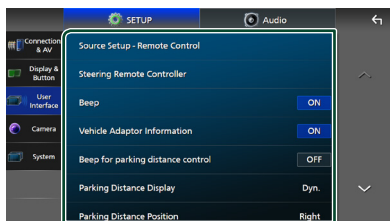

### ■ Source Setup - Remote Control

Select the sources to be switched with the remote controller. For how to operate the remote controller, see **Basic Operation (P.70)**.

### ■ Steering Remote Controller

Sets the desired function in the steering remote controller. (Contact your KENWOOD dealer for details.)

### ■ Beep

Turn the key touch tone on or off.  
Default is "ON".

### ■ Vehicle Adaptor Information \*1

Displays the vehicle information.  
This function requires a commercial adaptor.  
Consult your KENWOOD dealer for details.

### ■ Beep for Parking distance control \*1

Sets whether to generate a warning tone when the onboard proximity sensor detects a human or object.  
Consult your KENWOOD dealer for details.

### ■ Parking Distance Display \*1

You can display information about obstacles around the car.

**ON**: Always displays information.

**Dyn.** (Default): Displays information when the sensor detects obstacles.

**OFF**: Cancels.

This function requires a commercial adaptor.  
Consult your KENWOOD dealer for details.

### ■ Parking Distance Position \*1

Select where information about obstacles is displayed on the screen (left or right).

"Left"/"Right" (Default)

This function requires a commercial adaptor.  
Consult your KENWOOD dealer for details.

### ■ Driving Position

Select the driving position (left or right).

"Left" (Default)/"Right"

\*1 This setting is available when a commercial adaptor is connected.

## System Setup

You can setup system parameters.

- 1 Press the **HOME** /  $\text{\textcircled{P}}$  button.
- 2 Touch  $\text{\textcircled{S}}$ .
- 3 Touch **SETUP**.
  - ▶ SETUP Menu screen appears.
- 4 Touch **System**.
  - ▶ System setting menu appears.
- 5 Set each parameter as follows.



### ■ DEMO

Select the demonstration mode. Default is "ON".

### ■ Software Information

Confirm the software version of this unit.  
**(P.56)**

### ■ Open Source Licenses

Display the open source licenses.

### ■ Initialise

Touch **Initialise** and then touch **Yes** to set all the settings to the initial default settings.

- Audio SETUP Memory is not initialized.

### ■ Language Select

Select a language.

### ■ Time Format

### ■ Clock

### ■ Time Zone

### ■ Clock Adjust

You can set the date and time. See **Calendar/clock settings (P.8)**.

### ■ Security Code Set

### ■ Security Code Cancellation

### ■ Security Code Change

You can set up a security code. See **Security Code Setup (P.7)**.

## ■ Software Information

You can confirm the software version of this unit.

- 1 Touch **Software Information** in the System setting menu.
- 2 Confirm the software version.

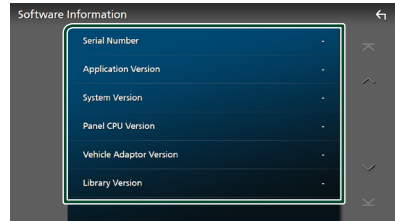

### NOTE

- For how to update the software, see the relevant update procedure manual which comes with the software.



# Controlling Audio

You can adjust various settings such as audio balance or subwoofer level.

- 1 Press the **HOME / ⏻** button.
- 2 Touch .
- 3 Touch **Audio**.

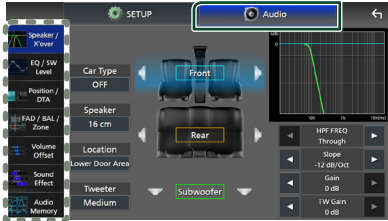

See the following section for each setting.



- Set up Speaker / X'over (**P.58**)
- Controlling EQ / SW Level (**P.59**)
- Set Position / DTA (**P.60**)
- Controlling FAD / BAL / Zone (**P.62**)
- Set Volume Offset (**P.64**)
- Set Sound Effect (**P.64**)
- Use Audio Memory (**P.68**)

## 3-way speaker system setup

Select the appropriate crossover network mode for the speaker system used (2-way or 3-way speaker system).

### ⚠ CAUTION

- Connecting 3-way speakers with the 2-way mode selected can break the speakers.

- 1 Press the **HOME / ⏻** button.
  - HOME screen appears.
- 2 Touch .
- Source selection screen appears.
- 3 Touch **STANDBY**.
- 4 Press  button ① followed by the **HOME / ⏻** button ② for 1 second at the same time.

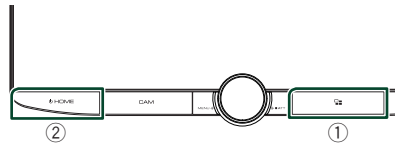

- Speaker system select screen appears.

- 5 Select the crossover network mode.

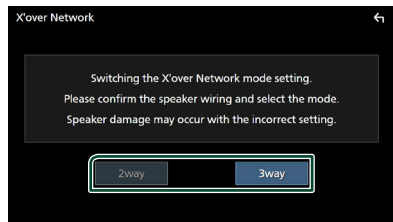

- A confirmation screen appears.

- 6 Touch **Yes**.

**NOTE**

- When the 3-way speaker system is selected, the following functions are disabled.
  - Front focus of Listening Position / DTA
  - Fader for Controlling General Audio
  - Zone Control
  - Selection of the speakers to output sound from the smartphone/cell-phone of Bluetooth HF/Audio
  - Beep for User Interface Setup
- While talking on the paired phone or using the voice recognition function, the speaker system cannot be switched.
- When the dual zone is selected and audio source other than "OFF" is selected as Rear Source, the speaker system cannot be switched to the 3-way mode.

**Speaker / X'over setup**

- 1** Press the **HOME** / **⏻** button.
- 2** Touch **⚙️**.
- 3** Touch **Audio**.
  - Audio screen appears.
- 4** Touch **Speaker / X'over**.
- 5** Select a car type.

You can select the car type and speaker network, etc.

When you select your car type, the Delay Time Alignment is activated automatically (for timing adjustment of sound output for each channel) to have the highest surround effects.

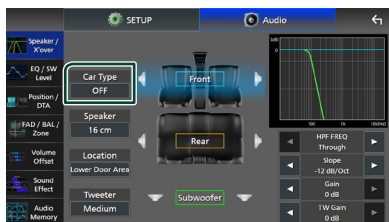

- 6** Touch the speaker (1) you wish to adjust and set each parameter (2) as follows.

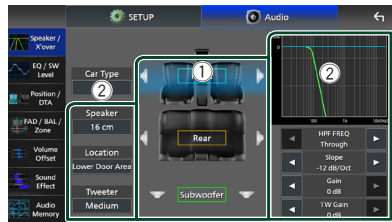

**Speaker**

You can select a speaker type and its size to get the best sound effects.

When the speaker type and size are selected, the speaker crossover network is set automatically.

**Location (Only for Front, Rear)**

Select the speaker position you have installed.

**Tweeter (Only for Front)**

You can set up the tweeter when you are selecting front speakers.

None, Small, Medium, Large

**HPF FREQ (Only for Front, Rear)**

High Pass Filter adjustment.

**LPF FREQ (Only for Subwoofer)**

Low Pass Filter adjustment.

**Slope**

Set a crossover slope.

**Gain**

Adjust the gain of the front speaker, rear speaker, or subwoofer.

**TW Gain (Only for Front)**

Adjust the tweeter level.

**Phase Inversion (Only for Subwoofer)**

Set the phase of subwoofer output.

Check **Phase Inversion** to shift the phase 180 degrees.

## When Speaker network is set to 3-way:

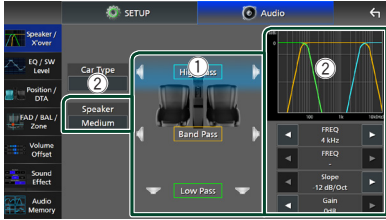

### ■ Speaker

You can select a speaker type and its size to get the best sound effects. If you have no speakers, select "None".

When the speaker type and size are selected, the speaker crossover network is set automatically.

### ■ FREQ (High Pass)

High Pass Filter adjustment. (Only for High Pass)

### ■ FREQ (Low Pass)

Low Pass Filter adjustment. (Only for Low Pass)

### ■ HPF FREQ, LPF FREQ (Only for Band Pass)

Band Pass Filter adjustment.

### ■ Slope \*1 \*2

Set a crossover slope.

### ■ Gain

Set the gain of each speaker.

### ■ Phase Inversion

Set the phase of tweeter, mid range, and woofer output.

Check **Phase Inversion** to shift the phase 180 degrees.

\*1 Only when "LPF FREQ"/"HPF FREQ" (Band Pass) is set to a mode other than "Through".

\*2 Only when "FREQ" (Low Pass) is set to a mode other than "Through".

## NOTE

- For how to switch to the 3-way speaker system, see **3-way speaker system setup (P.57)**.

## Equalizer Control

You can adjust equalizer by selecting the optimized setting for each category.

- 1 Press the **HOME** / **⏻** button.
- 2 Touch **⚙️**.
- 3 Touch **Audio**.  
➤ Audio screen appears.
- 4 Touch **EQ / SW Level**.
- 5 Touch the screen and set the **Graphic Equalizer** as desired.

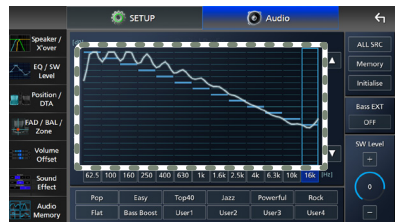

### ■ Gain level (area in dotted frame)

Adjust the gain level by touching each frequency bar.

You can select a frequency bar and adjust its level by **▲**, **▼**.

### ■ ALL SRC

Apply the adjusted equalizer curve to all sources. Touch **ALL SRC** and then touch **OK** on the confirmation screen.

### ■ Memory

Saves the adjusted equalizer curve as "User1" to "User4". **(P.60)**

### ■ Initialise

Initialize (flatten) the current EQ curve.

### ■ Bass EXT (Bass Extend Settings)

When turned on, the frequencies lower than 62.5 Hz is set to the same gain level (62.5 Hz).

### ■ SW Level

Adjust the subwoofer volume. This setting is not available when Subwoofer is set to "None". See **Speaker / X'over setup (P.58)**.

### ■ Pop / Easy / Top40 / Jazz / Powerful / Rock / Flat / Bass Boost / User1 / User2 / User3 / User4

Recall the preset EQ curve.

## Controlling Audio

### Save the EQ curve

- 1 Adjust the EQ curve.
- 2 Touch **Memory**.
- 3 Select where to save.

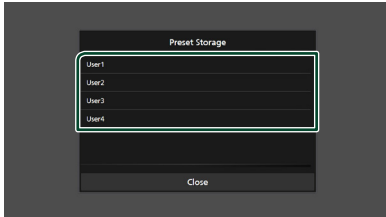

## Listening Position / DTA

Listening Position / DTA allows you to improve the sound field depending on the position of the seat you sit.

Listening Position / DTA allows you to set "Listening Position" and "Front Focus". You cannot set both at the same time.

- 1 Press the **HOME / ⏻** button.
- 2 Touch **⚙️**.
- 3 Touch **Audio**.
  - Audio screen appears.
- 4 Touch **Position / DTA**.

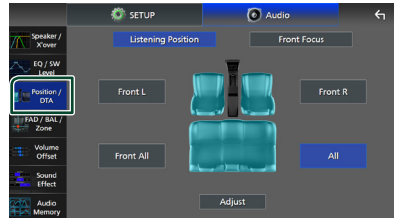

- Set up Listening Position (**P.60**)
- Set up Front Focus (**P.61**)

### Listening Position

Adjust the sound delay time so that the sounds from different speakers arrive at the listener sitting on the selected seat at the same time.

- 1 Touch **Listening Position** on the Position / DTA screen.
- 2 Select a listening position from **Front R** (Right front), **Front L** (Left front), **Front All** (All front), and **All**.

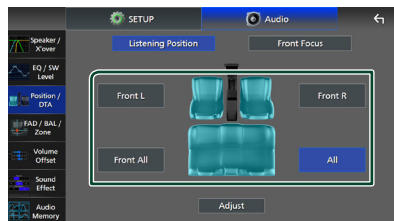

## Position DTA control

You can fine-adjust your listening position.

- 1 Touch **Adjust**.
- 2 Touch **Delay**.
- 3 Touch ◀ or ▶ to adjust the delay time of the selected speaker.

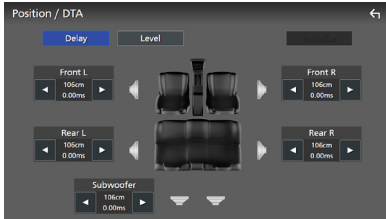

- 4 Touch **Level**.
- 5 Touch ◀ or ▶ to adjust the sound level of the selected speaker.

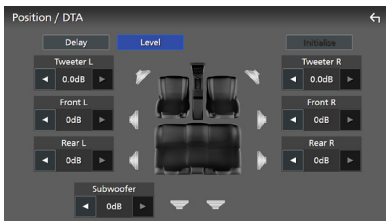

### NOTE

- To initialize the Delay and Level settings, touch **Initialize** and **YES** on the confirmation screen.

## Front Focus

You can focus the imaginary sound image on the front of the selected seat.

- 1 Touch **Front Focus** in the Position / DTA screen.
- 2 Select a front focus position.

For **Front All** and **All**, select Priority L or R depending on which side you want to put the imaginary sound image.

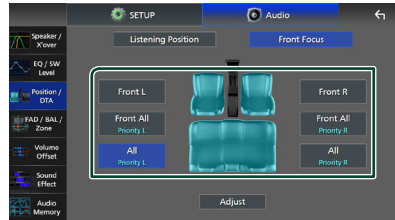

### NOTE

- When the 3-way speaker system is selected, front focus feature is disabled.

## Front Focus fine adjustment

- 1 Touch **Adjust**.
- 2 Touch **Delay**.
- 3 Set each parameter as follows.

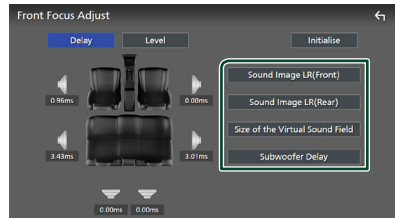

### ■ Sound Image LR (Front)

Focus the sound image on the front of front seats.

### ■ Sound Image LR (Rear)

Focus the sound image on the front of rear seats.

## Controlling Audio

### ■ Size of the Virtual Sound Field

Adjust the size of sound image to meet your taste. If the sound image is shifted from the front, move it back by **Sound Image LR (Front)** or **Sound Image LR (Rear)**.

### ■ Subwoofer Delay

Adjust the delay time of subwoofer sound.

#### 4 Touch **Level**.

#### 5 Touch ◀ or ▶ to adjust the sound level of the selected speaker.

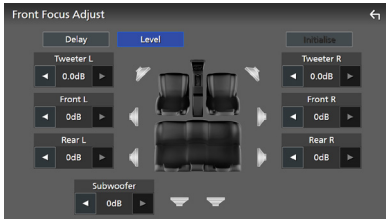

#### NOTE

- To initialize the Delay and Level settings, touch **Initialise** and **YES** on the confirmation screen.

## Fader / Balance / Zone Control

#### 1 Press the **HOME / ⏻** button.

#### 2 Touch **⚙️**.

#### 3 Touch **Audio**.

- Audio screen appears.

#### 4 Touch **FAD / BAL / Zone**.

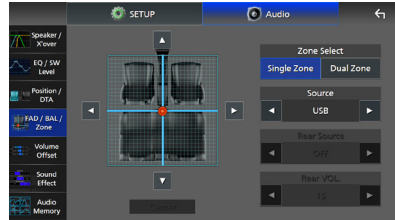

- Fader / Balance Control (P.62)
- Set up Zone Control (P.63)

### ■ Fader / Balance Control

You can adjust the volume balance among the speakers.

#### 1 Touch ◀, ▶, ▲, and ▼ to adjust the volume balance.

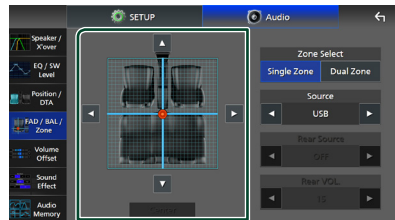

◀ and ▶ adjust the left and right volume balance.

▲ and ▼ adjust the front and rear volume balance.

### ■ Center

Clear the adjustment.

#### NOTE

- When the 3-way speaker system is selected, "Fader" adjustment is disabled.

## Zone Control

You can select different sources for front and rear positions in the vehicle.

### 1 Touch **Dual Zone** on the FAD / BAL / Zone screen.

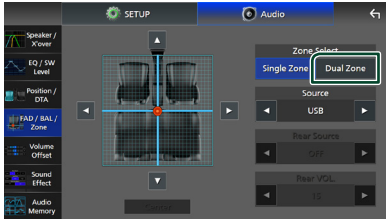

#### Source

You can switch the current source.

### 2 Set each source as follows.

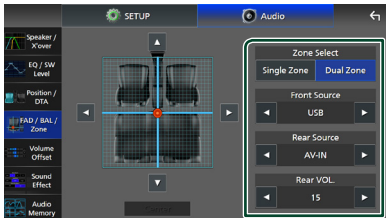

#### Zone Select

Touch **Single Zone** to turn off the dual zone function.

#### Front Source, Rear Source

Select an audio source for each.

Rear Source;

"AV-IN"/"iPod"/"USB"/"OFF"

#### Rear VOL.

Adjust the rear source volume.

## NOTE



- When the rear source is switched, the audio source that is output at the AV OUTPUT terminal is also switched to the same source.
- When the dual zone function is set to on, the following functions are not available.
  - Output from the subwoofer
  - Subwoofer Level/Bass Boost (**P.64**)
  - Equalizer Control/Sound Effect/Listening Position (**P.59, 64, 60**)
  - Speaker Setup (**P.58**)
  - Fader for Controlling General Audio
  - High-resolution Sound Source File Playback
- When the dual zone is selected and audio source other than "OFF" is selected as Rear Source, the speaker system cannot be switched.
- You cannot select AV-IN if the Video input terminal is used for camera.

## Rear Source

- You cannot select iPod if it is connected via Bluetooth or Apple CarPlay is connected.
- If you select iPod as the Front Source, you cannot select USB as the Rear Source.
- If you select USB as the Front Source, you cannot select iPod as the Rear Source.
- If you select HDMI as the Front Source, files with sampling rates higher than 96 kHz in USB selected as the Rear Source are skipped.
- If you select Bluetooth audio, Radio, Digital Radio, Wireless Mirroring, Apple CarPlay or Android Auto as the Front Source, you cannot select USB or iPod as the Rear Source.

## Volume Offset

Finely adjust the volume of the current source to minimize the difference in volume between different sources.

- 1 Press the **HOME** /  button.
- 2 Touch .
- 3 Touch **Audio**.
  - Audio screen appears.
- 4 Touch **Volume Offset**.
- 5 Touch **+** or **-** to adjust the level.

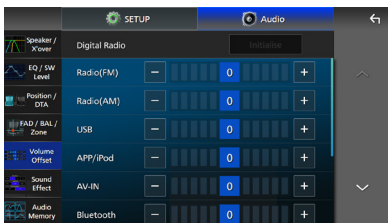

### ■ Initialise



Returns to the initial settings.  
Touch **Initialise** and then touch **YES** on the confirmation screen.

### NOTE

- If you have increased the volume first, then reduce the volume using "Volume Offset". Switching the current source to another source suddenly may output extremely loud sound.

## Sound Effect

You can set sound effects.

- 1 Press the **HOME** /  button.
- 2 Touch .
- 3 Touch **Audio**.
  - Audio screen appears.
- 4 Touch **Sound Effect**.

## 5 Set each parameter as follows.



### ■ Bass Boost

Set the amount of bass boost  
"OFF"/"1"/"2"/"3".

### ■ Loudness

Set the amount of boost of low and high tones.  
"OFF"/"Low"/"High"

### ■ Drive Equalizer

Reduces the driving noise by raising the bandwidth.  
"OFF"/"ON"

### ■ Space Enhancer

Select the feeling of sound space enhancement.  
"OFF"/"Small"/"Medium"/"Large".  
This setting is not available for the Digital Radio and tuner source.

### ■ Supreme

Turn ON/OFF the Supreme function.  
Technology to extrapolate and supplement with proprietary algorithm, the high-frequency range that is cut off when encoding.

### ■ Realizer

Virtually make the sound more realistic using the Digital Signal Processor (DSP) system.  
Select the level from "OFF"/"1"/"2"/"3".

### ■ Stage EQ

You can adjust the height of speakers virtually to suit your listening position.  
"OFF"/"Low"/"Middle"/"High".

### ■ Parametric EQ

When set to "ON", you can use the parametric equalizer. For details, see **Parametric Equalizer (P.65)**.



## Parametric Equalizer

In addition to the conventional Graphic Equalizer, this unit has a parametric equalizer, which allows you more precise adjustments. By using each equalizer properly, you can calibrate the unit more thoroughly. Adjustment using this function requires expertise.

### When to Use Each Function

#### ● Parametric Equalizer

Use this to finely correct or improve the frequency characteristics of the acoustics of the car in order to establish a basis for adjustments.

Practiced ears or a measuring equipment may be required to apprehend the problems of the sound field inside the car.

#### ● Graphic Equalizer

Use this to actively create an attractive sound as conventionally.

Everybody can easily get the result through trial and error of intuitive operations.

Even more effective adjustments are possible when the basis is established by using the Parametric Equalizer.

### About the Parametric Equalizer

This system allows you to freely control the filter, frequency, Q factor (acuteness) and slope gain at 14 points consisting of 9 points common for front/rear/subwoofer, 2 points for front only, 2 points for rear only, and one point for subwoofer only.

#### NOTE

- Configure the Parametric Equalizer to establish the basis for adjustments before making adjustments using the Graphic Equalizer.
- The changes made using the Parametric Equalizer are not shown on the Graphic Equalizer screen.
- You can check the effects using the Parametric Equalizer ON/OFF key.

### About Adjustments

If there are unpleasant peaks, you can slide the peaking filter to the left or right and search the frequencies by ear. Studio engineers use this method to make adjustments quickly and efficiently.

However, in order to identify peaks and dips of a car audio system, you have to capture the pink noise outputted from the speaker using a microphone and analyze it using a real time analyzer (RTA). From the analysis result, identify the peaks and/or dips that need to be corrected and configure the filters to cancel them.

### About the Filters of Parametric Equalizer

Filters allow you to remove or extract specific sound through signal processing.

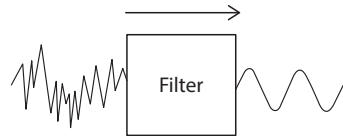

#### NOTE

- Cutoff frequency is the boundary between the passband and the stopband. The definition of cutoff frequency is a frequency for which the output is -3 dB of the nominal passband value.

● **High-Pass Filter**

Passes signals with frequencies higher than a certain frequency ( $f_c$ : cutoff frequency) and attenuates signals with frequencies lower than the cutoff frequency. Use this to pass only high-frequency signals. Use this in the following cases for example:

- For extracting the frequency band for separate tweeters. By extracting the specific frequency band, level adjustment can be made to the frequency band individually.
- The sound may be muddy when you play back low frequency sound. This occurs when frequencies below the speaker capacity is inputted. To cancel this, use the high-pass filter to cut off the frequencies below the speaker capacity.

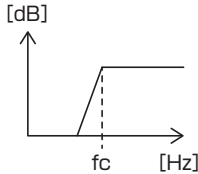

● **High-Shelving Filter/Low-Shelving Filter**

These filters reduce or increase signals above or below a certain frequency ( $f_c$ : cutoff frequency), which create shelves in the frequency spectrums. A high-shelving filter reduces or increases the frequencies above the target frequency and a low-shelving filter reduces or increases the frequencies below the target frequency. The low shelf controls the lower frequencies and the high shelf controls the high frequencies. Use these in the following cases for example:

- When you want to change the volume of the tweeters, for example when they are close to your ears and are sounding too loud.
- When you want to change the subwoofer volume at hand.

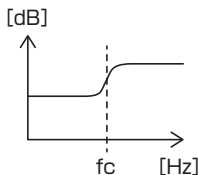

● **Peaking Filter**

The frequencies in the vicinity of a certain frequency ( $f_0$ : center frequency) are boosted or attenuated. Use this in the following cases for example:

- When you want to control a narrow range of frequencies to correct the frequency abnormality in the car.
- To diminish a chattering noise from the speaker by attenuating the frequency range of the noise.
- To adjust of the sound balance of the whole range between the low end and the high end.

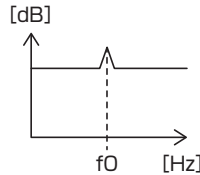

● **Low-Pass Filter**

Passes signals with frequencies lower than a certain frequency ( $f_c$ : cutoff frequency) and attenuates signals with frequencies higher than the cutoff frequency. Use this to pass only low-frequency signals. Use this in the following cases for example:

- For extracting the low frequencies band for a subwoofer.
- For extracting middle/low frequencies when you are using speakers with separate tweeters and you want to output the high frequencies to the tweeters and output the middle/low frequencies to the woofers.
- To cut the high frequencies when they are too loud.

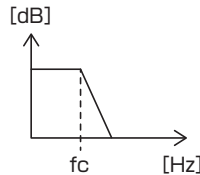

## Adjust the Parametric Equalizer

### Preparation

- Correct the value in "Listening Position" and "Front Focus" before adjusting the parametric equalizer. See *Listening Position / DTA (P.60)*.

- Press the **HOME** /  $\text{\textcircled{P}}$  button.
- Touch  $\text{\textcircled{S}}$ .
- Touch **Audio**.
- Touch **Sound Effect**.
- Set the Parametric EQ to **ON** and touch **Yes**.
- Touch **SETUP**.
  - Parametric EQ screen appears.
- While auditioning music, move the peaking filter to the left and right to search for unpleasant peaks and suppress them.
- Use pink noise and an analyzer to identify dips, as dips are difficult to find. Correct steep (10 dB or greater) peaks and dips as these are generally regarded as obstructions to sound quality.
- Set each parameter as follows.



### 1 Speaker

Select the speaker.

**When Speaker network is set to 2-way:**

"Common" / "Front" / "Rear" / "Subwoofer"

**When Speaker network is set to 3-way:**

"Common" / "Tweeter" / "Middle" / "Woofers"

### 2 EQ points/curve

Displays the EQ point and the curve. Adjust the EQ points by touching.

**EQ point (red):** The EQ point currently being adjusted.

**EQ point (blue/yellow):** EQ points that are not currently being adjusted.

**Curve (orange):** EQ curve of the speaker currently being adjusted.

**Curve (blue):** Overall EQ curve.

### 3 Filter

Select the filter.

"High Pass" / "High Shelving" / "Peaking" / "Low Shelving" / "Low Pass"

### 4 Affects All Speakers \*1

- ON:** Outputs sound from all speakers.
- OFF:** Outputs sound from the currently selected speaker only.

### 5 Initialise / Flat

- Initialise:** Initialize (flatten) the adjustment of all the speakers.
- Flat:** Initialize (flatten) the adjustment of the current speaker.

### 6 Frequency / Gain

Set the frequency and gain.

◀ and ▶ adjust the frequency.

▲ and ▼ adjust the gain.

### NOTE

- Touch the EQ point to roughly determine the frequency and gain, then use this key to make fine adjustments.

### 7 Q / Slope\*2

Set the Q factor and slope.

### 8 Point

Select the EQ point to adjust.

### 9 Preset

- User1 / User2 / User3:** Recalls the preset EQ.
- Memory:** Stores the current EQ settings.

\*1 Only when the speaker other than "Common" is selected.

\*2 When "Peaking" filter is selected, you can adjust the Q factor. When "High Pass" or "Low Pass" filter is selected, you can adjust the slope.

### NOTE

- You can adjust the EQ points and curve based on a preset EQ. Recall the preset EQ and touch the preset key again to unselect it before adjustment.

## Controlling Audio

**10** When you have finished adjustments, save the results as a preset, and check the effects by switching presets or turning the Parametric EQ **ON** and **OFF**.

**11** Use the Graphic Equalizer to make final adjustments. (P.59)

## Audio Setup memory

Audio Control settings can be memorized. The memorized settings can be recalled at any time.

- 1** Press the **HOME** / **⏻** button.
- 2** Touch **⚙️**.
- 3** Touch **Audio**.  
➤ Audio screen appears.
- 4** Touch **Audio Memory**.

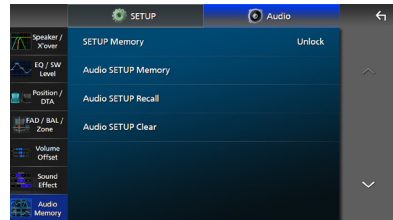

### ■ **SETUP Memory**

Lock or unlock the Audio SETUP Memory/ Recall/Clear.

### ■ **Audio SETUP Memory**

Memorize the current audio settings.

- FAD / BAL / Zone, Speaker / X'over, Equalizer (User Preset, SW Level), Position / DTA, Sound Effect **(P.57)**

### ■ **Audio SETUP Recall**

Recall the memorized audio setting.

### ■ **Audio SETUP Clear**

Clear the Audio SETUP Memory and the currently memorized audio settings.

# Remote control

This unit can be operated using the remote control KNA-RCDV331 (optional accessory).

## ▲ CAUTION

- Risk of fire or explosion if the battery is replaced by an incorrect type. Ensure to replace only with the same type.
- Risk of fire, explosion or the leakage of flammable liquid or gas if the battery is left in an extremely high temperature surrounding environment and/or subjected extremely low air pressure. The battery pack or batteries shall not be exposed to excessive heat such as sunshine, fire or the like.
- Risk of fire, explosion or the leakage of flammable liquid or gas if the battery is disposed into fire or a hot oven, recharged, shorted, mechanically crushed or cut of the battery.
- If spilled fluid comes in contact with your eyes or on clothing, immediately rinse with water and consult a physician.

## Battery Installation

If the remote control operates only over shorter distances or does not operate at all, it is possible that the batteries are depleted. In such instances, replace the both batteries with new ones.

- 1 Insert two "AAA"/"R03"-size batteries with the ⊕ and ⊖ poles aligned properly, following the illustration inside the case.

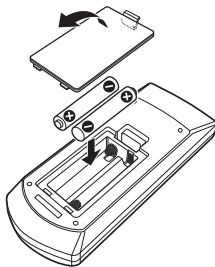

## Functions of the Remote control Buttons

### ■ Switch the operation mode

The functions operated from the remote control differ depending on the position of the mode switch.

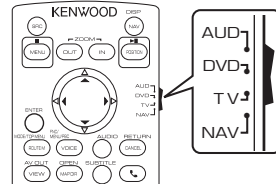

#### ■ AUD mode

Switch to this mode when controlling a selected source or tuner source, etc.

■ DVD mode/TV mode/NAV mode  
Not used.

### NOTE

- When controlling a player that is not integrated in the unit, select "AUD" mode.

### ■ Direct search mode

Using the remote control, you can jump directly to the desired frequency value of the Radio source by entering the number corresponding to the content.

### NOTE

- This operation cannot be performed for the USB device and iPod.

- 1 Press the #BS button.
- 2 Enter the number of the content you want to play using the numeric keypad.
- 3 Press the ◀ or ▶ button.
  - ▶ The content corresponding to the number you entered is played.

**Basic Operation**

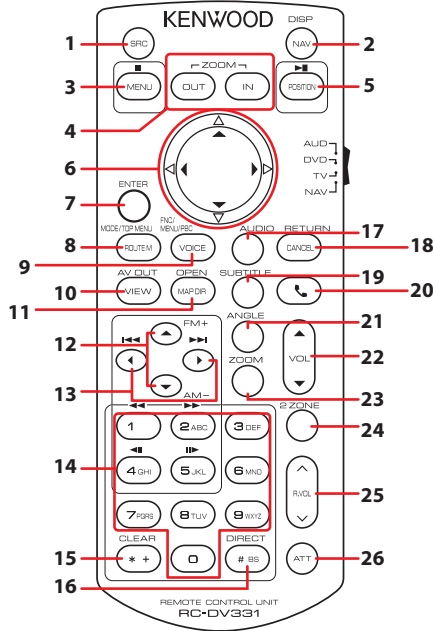

	Key Name	Mode switch	Function
1	SRC	AUD	Switches to the source to be played. (P.55) In Hands-Free mode, hangs up the phone.
2	NAV	–	Displays the APP (Apple CarPlay/Android Auto/Wireless Mirroring) screen.
3	MENU	–	Not used.
4	OUT, IN	–	Not used.
5	POSITION	AUD	Pauses the track or file, and resumes playing by pressing twice. For the Radio and Digital Radio sources, switches the seek mode.
6	Cursor Key	–	Not used.
7	ENTER	–	Not used.
8	ROUTE M	AUD	Screen mode changes each time you press this key during video playback.
9	VOICE	AUD	Displays the control screen of current source. (USB)
10	VIEW	AUD	Switches the AV source to be output.
11	MAP DIR	AUD	Not used.
12	▲/▼	AUD	Selects the folder to be played. For the Radio source, selects FM/AM band to be received.
13	◀/▶	AUD	Selects the track or file to be played. For the Radio and Digital Radio sources, switches to broadcast stations received by the unit.

	Key Name	Mode switch	Function
14	Numeric Keypad	AUD	For the Radio and Digital Radio sources, allows you to enter the preset number. <ul style="list-style-type: none"> <li>• If the preset number is one digit, press the number.</li> <li>• If the preset number is two digits, press continuously the numbers within 3 seconds.</li> <li>• Pressing ◀▶ within 3 seconds allows you to determine the preset number of one digit.</li> </ul> Allows you to enter the number to search in the direct search mode. For details on the direct search mode, see <b>Direct search mode (P.69)</b> .
15	* +	–	Not used.
16	# BS	AUD	Switches to the direct search mode. For details on the direct search mode, see <b>Direct search mode (P.69)</b> .
17	AUDIO	–	Not used.
18	CANCEL	–	Not used.
19	SUBTITLE	–	Not used.
20		–	When a call comes in, answers the call.
21	ANGLE	–	Not used.
22	Vol ▲▼	–	Adjusts the volume.
23	ZOOM	–	Not used.
24	2 ZONE	AUD	Switches the Dual Zone function on and off.
25	R.VOL ^▼	–	Adjusts volume at rear when the Dual Zone function is on.
26	ATT	–	Lowers the volume when pressed once. Restores the previous volume when pressed twice.

# Connection/Installation

This section is for the professional installer. For safety's sake, leave wiring and mounting to professionals. Consult the car audio dealer.

## Before Installation

Before installation of this unit, please note the following precautions.

### ▲ WARNINGS

- If you connect the ignition wire (red) and the battery wire (yellow) to the car chassis (ground), you may cause a short circuit, that in turn may start a fire. Always connect those wires to the power source running through the fuse box.
- Do not cut out the fuse from the ignition wire (red) and the battery wire (yellow). The power supply must be connected to the wires via the fuse.

### ▲ CAUTION

- Install this unit in the console of your vehicle. Do not touch the metal part of this unit during and shortly after the use of the unit. Metal part such as the heat sink and enclosure become hot.

### NOTE

- Mounting and wiring this product requires skills and experience. For best safety, leave the mounting and wiring work to professionals.
- Do not install the unit if it becomes an obstacle to driver performance.
- Adjust the panel position not to become an obstacle to driver performance.
- Make sure to ground the unit to a negative 12V DC power supply.
- Do not install the unit in a spot exposed to direct sunlight or excessive heat or humidity. Also avoid places with too much dust or the possibility of water splashing.
- Do not use your own screws. Use only the screws provided. If you use the wrong screws, you could damage the unit.

- If the power is not turned ON ("There is an error in the speaker wiring. Please check the connections." is displayed), the speaker wire may have a short-circuit or touched the chassis of the vehicle and the protection function may have been activated. Therefore, the speaker wire should be checked.
- If your car's ignition does not have an ACC position, connect the ignition wires to a power source that can be turned on and off with the ignition key. If you connect the ignition wire to a power source with a constant voltage supply, such as with battery wires, the battery may be drained.
- If the console has a lid, the lid will not be closed even when the unit is installed correctly.
- If the fuse blows, first make sure the wires are not touching to cause a short circuit, then replace the old fuse with one with the same rating.
- Insulate unconnected wires with vinyl tape or other similar material. To prevent a short circuit, do not remove the caps on the ends of the unconnected wires or the terminals.
- Connect the speaker wires correctly to the terminals to which they correspond. The unit may be damaged or fail to work if you share the ⊖ wires or ground them to any metal part in the car.
- When only two speakers are being connected to the system, connect the connectors either to both the front output terminals or to both the rear output terminals (do not mix front and rear). For example, if you connect the ⊕ connector of the left speaker to a front output terminal, do not connect the ⊖ connector to a rear output terminal.
- After the unit is installed, check whether the brake lamps, blinkers, wipers, etc. on the car are working properly.
- Mount the unit so that the mounting angle is 30° or less.
- This unit has the cooling fan to decrease the internal temperature. Do not mount the unit in a place where the cooling fan of the unit is blocked. Blocking these openings will inhibit the cooling of the internal temperature and result in malfunction.



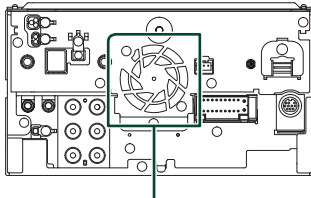

Cooling fan

- Do not press hard on the panel surface when installing the unit to the vehicle. Otherwise scars, damage, or failure may result.
- Reception may drop if there are metal objects near the Bluetooth/Wi-Fi antenna.

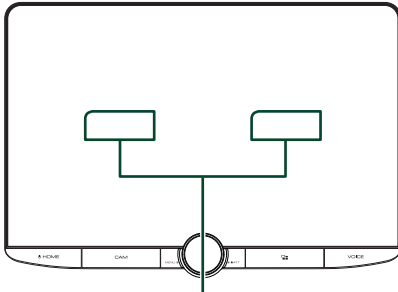

Bluetooth/Wi-Fi antenna unit

● **Forward and Lateral Fields of Vision**

- To determine driver's forward and lateral fields of vision under normal conditions, place a pole (directly visible from the front or visible through the car rear-view mirror) as shown.

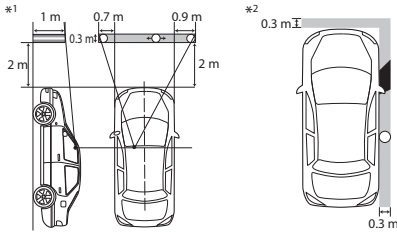

- : Pole (height: 1m, diameter: 0.3m)
- : Field of vision from steering position
- : Exempted area (pole size is subject to regulation)

- For right hand drive vehicles, standards are reversed.

\*1 The pole must be visible from the driver's position as direct forward field of vision.

\*2 The pole must be directly visible or indirectly visible through the mirror, etc. from the driver's position.

■ **Supplied accessories for installation**

①		x1
②		x1
③		x1
④		x6
⑤		x6
⑥		x1
⑦		x1
⑧		x1
⑨		x2
⑩		x1
⑪		x6

## Connection/Installation

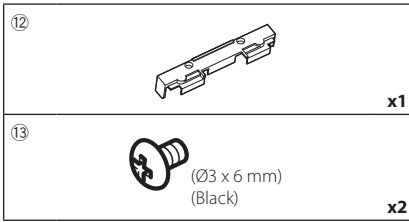

### Installation procedure

- 1) To prevent a short circuit, remove the key from the ignition and disconnect the  $\ominus$  terminal of the battery.
- 2) Remove the vehicle parts for installing the unit and connecting wires to terminal.
- 3) Make the proper input and output wire connections for each unit.
- 4) Determine the height of the display unit and position of the slider. See **Distance between the display unit and the main unit (P.75)**.
- 5) Take Connector B on the wiring harness and connect it to the speaker connector in your vehicle.
- 6) Take Connector A on the wiring harness and connect it to the external power connector on your vehicle.
- 7) Connect the wiring harness connector to the unit.
- 8) Install the main unit to the vehicle.
- 9) Reinstall the vehicle parts.
- 10) Install the display unit.
- 11) Reconnect the  $\ominus$  terminal of the battery.
- 12) Perform the Initial Setup.  
See **Initial SETUP (P.6)**.

## Installing the unit

### Confirm the installing position of the display unit

#### ● Vehicles cannot be installed

It may be possible to install if it can avoid the following by adjustment for slider position and display height.

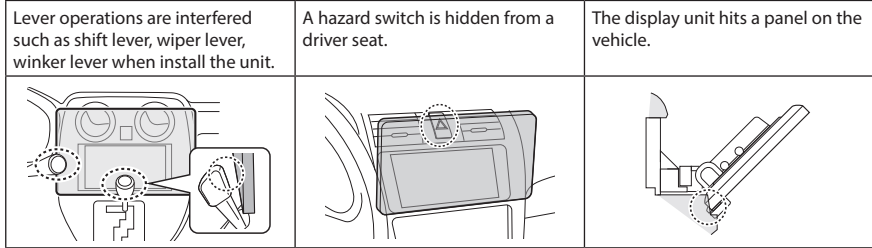

#### ● Distance between the display unit and the main unit

Adjust slider position and display height so that it does not interfere with display movement.

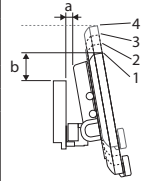
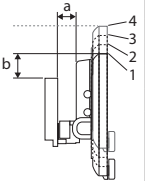
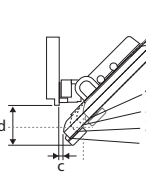
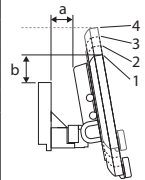
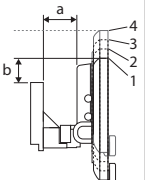
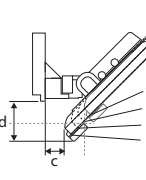
Slider position	Display angle				Display height			
	-10°	0°	45°		1	2	3	4
Back position				-10°	a	10		
	b	38.1	50.9		63.8	76.5		
	0°	a	26.7					
		b	34.7	47.7	60.7	73.7		
	45°	c	5.7	14.4	24.1	33.4		
		d	55.4	46.3	37.1	27.8		
Forward position				-10°	a	30.1		
	b	38.1	50.9		63.8	76.5		
	0°	a	46.7					
		b	34.7	47.7	60.7	73.7		
	45°	c	25.7	34.9	44.1	53.3		
		d	55.4	46.3	37.1	27.8		

Unit: mm

#### Examples

Cluster panel on the vehicle

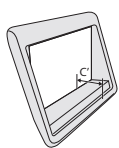

Slider in back position

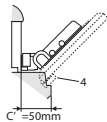

Slider in forward position

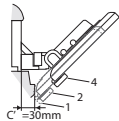
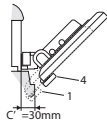
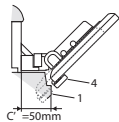

• C'=50mm;  
Slider position: Forward position  
Display height: Set only "4"

• C'=30mm;  
Slider position: Back position  
Display height: Set only "4"

Slider position: Forward position  
Display height: Set "2"~"4"

## Positioning the slider in forward

- 1 Remove the four screws from the bottom of the main unit.

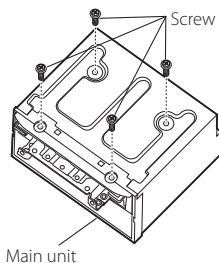

- 2 Remove the two covers for back position, and then remove the two hexagon head screws from the bracket for back position.

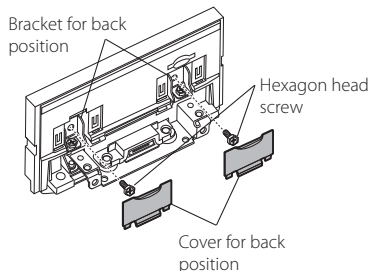

- 3 Pull the slider block forward and remove the two hexagon head screws to remove the bracket for back position.

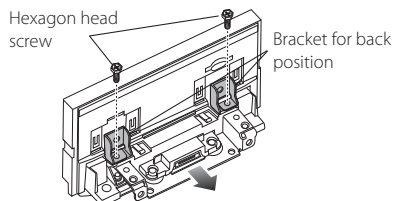

- 4 Install the bracket for forward position (accessory 10) each side so that its projections are aligned with the slots on the main unit.

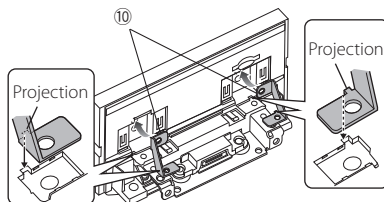

- 5 Fix the bracket for forward position to the slider block with the two hexagon head screws. Push the slider block until it stops and then fix the bracket for forward position to the main unit with the two hexagon head screws.

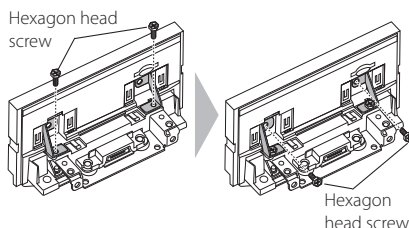

- 6 Reinstall the four screws to the bottom of the main unit.

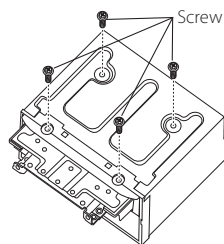

- 7 Install the cover for forward position (accessory 9) to two locations, as shown.

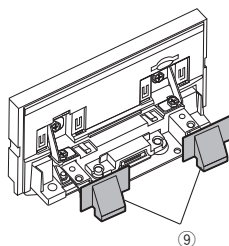

## Adjusting the display height

- 1 Remove the four flat head screws from both sides.

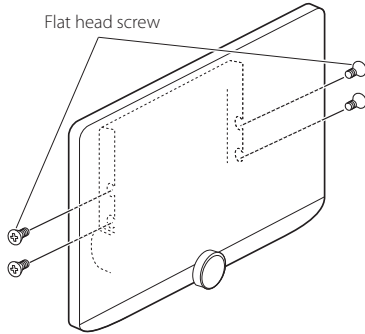

- 2 Adjust the display height according to the screw hole position. Default is "1".

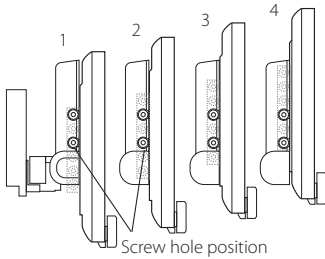

- 3 Reinstall the four flat head screws on both sides and fix the display.

### NOTE

- Fix with flat head screws correctly. After installing the display unit (accessory ⑧) to the main unit, tilt the display forward until it stops and confirm that the display unit (accessory ⑧) does not hit vehicle parts. If the display unit hits vehicle parts, adjust the display height again.

## GPS antenna

GPS antenna is installed inside of the car. It should be installed as horizontally as possible to allow easy reception of the GPS satellite signals.

To mount the GPS antenna inside your vehicle:

- 1) Clean your dashboard or other surface.
- 2) Remove the separator of the metal plate (accessory ⑦).
- 3) Press the metal plate (accessory ⑦) down firmly on your dashboard or other mounting surface. You can bend the metal plate (accessory ⑦) to conform to a curved surface, if necessary.
- 4) Remove the separator of the GPS antenna (accessory ⑥), and stick the antenna to the metal plate (accessory ⑦).

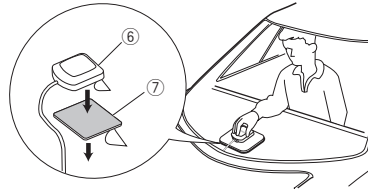

### NOTE

- Use the supplied GPS antenna. Using the GPS antenna other than the supplied one may cause a drop in positioning accuracy.
- Depending on the type of car, reception of the GPS satellite signals might not be possible with an inside installation.
- Please install this GPS antenna in an area away from any antennas that are used with CB radios or satellite televisions.
- The GPS antenna should be installed at a position that is spaced at least 12 inch (30 cm) from smartphone/cell-phone or other transmitting antennas. Signals from the GPS satellite may be interfered with by these types of communication.
- Painting the GPS antenna with (metallic) paint may cause a drop in performance.

## Microphone unit

- 1) Check the installation position of the microphone (accessory ③).
- 2) Clean the installation surface.
- 3) Remove the separator of the microphone (accessory ③), and stick the microphone to the place shown below.
- 4) Wire the microphone cable up to the unit with it secured at several positions using tape or other desired method.
- 5) Adjust the direction of the microphone (accessory ③) to the driver.

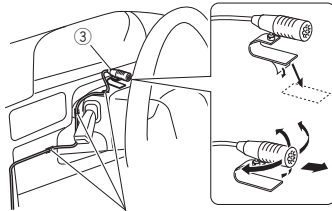

Fix a cable with a commercial item of tape.

## Installing the main unit

### NOTE

- Determine the slider position before installing the main unit. **(P.76)** The slider position cannot be changed after installing to the vehicle.
- Make sure that the unit is installed securely in place. If the unit is unstable, it may malfunction (eg, the sound may skip).

- 1 Remove parts that interfere with installing such as a panel on the vehicle.

- 2 Install the car bracket to the main unit.

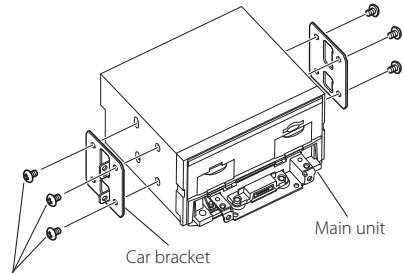

④ or ⑤

- 3 Connect the wiring harness wires and peripheral equipment.

- 4 Install the main unit to the vehicle.

- 5 Reinstall the removed parts such as a panel on the vehicle.

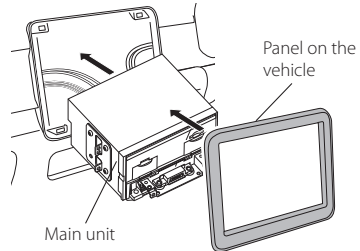

**6** Install the display unit (accessory ⑧) to the main unit.

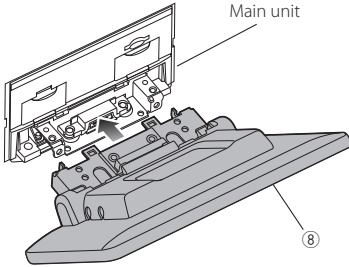

**NOTE**

- If the display unit hits a panel on the vehicle, adjust the display height by referring to **Adjusting the display height (P.77)**.

**7** Fix the display unit with six hexagon head screws (accessory ⑪).

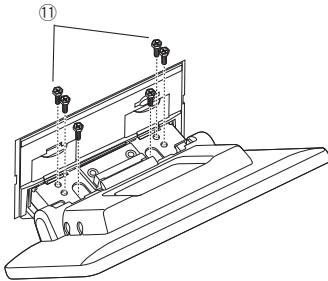

**8** Attach the protective cover (accessory ⑫) to coupling part, and then fix it with two binding head screws (accessory ⑬).

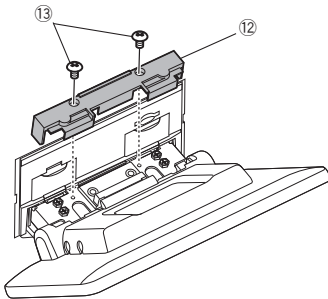

**NOTE**

- If the protective cover (accessory ⑫) is not attached, this unit will not turn on. Even if the unit is turned on, the power may be turned off halfway.  
Be sure to attach the protective cover (accessory ⑫).

**9** Raise the display manually.

## Connecting wires to terminals

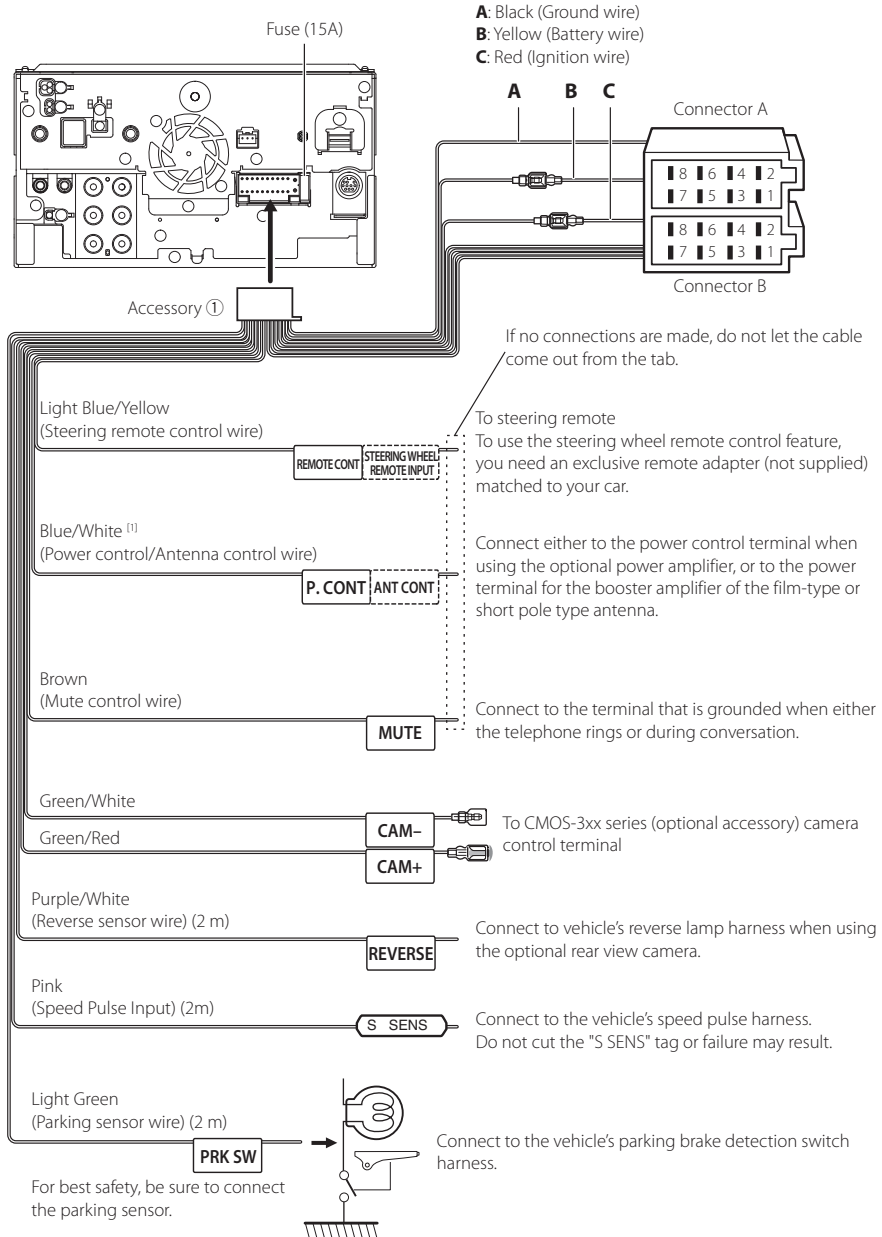

[1] [2]: Blue/White wire is provided two wires, [1] and [2]. Blue/White wire total output ([1] + [2]): 12 V  $\approx$  350 mA



### 3-way speaker system setup

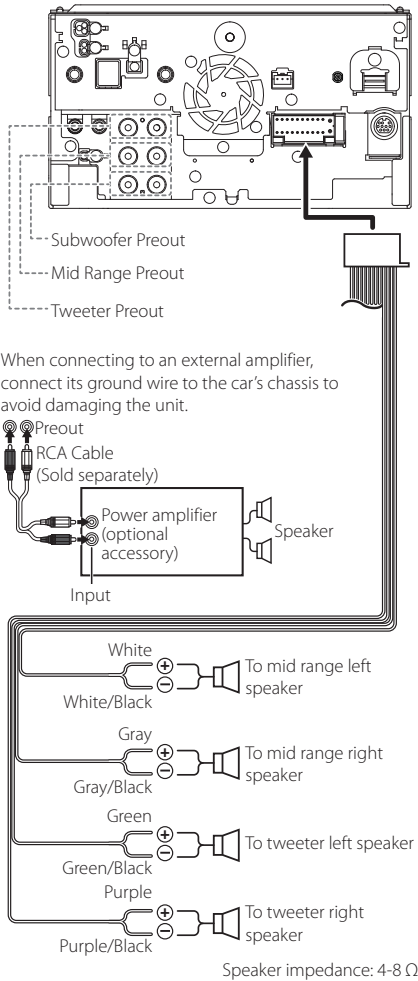

#### NOTE

- For speaker system setup, see **3-way speaker system setup (P.57)**.
- For speaker setup and crossover setup, see **Speaker / X'over setup (P.58)**.
- For how to connect speaker wires to terminals other than speaker terminals and Preout terminals, see **Connecting the system and external components (P.82)** and **Connecting wires to terminals (P.80)**.

### Wiring harness (Accessory ①) connector function guide

Pin	Color and function	
A-4	Yellow	Battery
A-5	Blue/White <sup>[2]</sup>	Power Control
A-6	Orange/White	Dimmer
A-7	Red	Ignition (ACC)
A-8	Black	Earth (Ground) Connection
B-1/B-2	Purple (+) / Purple/Black (-)	Rear Right
B-3/B-4	Gray (+) / Gray/Black (-)	Front Right
B-5/B-6	White (+) / White/Black (-)	Front Left
B-7/B-8	Green (+) / Green/Black (-)	Rear Left

\*Speaker Impedance: 4-8 Ω

[1] [2]: Blue/White wire is provided two wires, [1] and [2].  
Blue/White wire total output ([1] + [2]):  
12 V = 350 mA

#### ⚠ WARNING for Connecting the ISO Connector

The pin arrangement for the ISO connectors depends on the type of vehicle you drive. Make sure to make the proper connections to prevent damage to the unit. The default connection for the wiring harness is described in (1) below. If the ISO connector pins are set as described in (2), make the connection as illustrated. Please be sure to reconnect the cable as shown (2) below to install this unit to the Volkswagen vehicles etc.

##### (1): Default setting

The red (A-7 pin) of the vehicle's ISO connector is linked with the ignition, and the yellow (A-4 pin) is connected to the constant power supply.

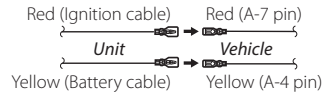

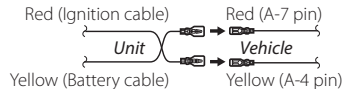

##### (2)

The red (A-7 pin) of the vehicle's ISO connector is connected to the constant power supply, and the yellow (A-4 pin) is linked to the ignition.

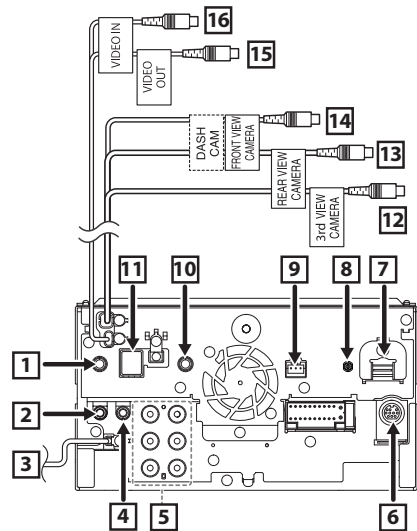

## Connecting the system and external components

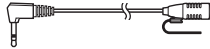
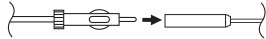

<b>1</b>	Connect to vehicle's steering remote harness. Contact your KENWOOD dealer for details.
<b>2</b>	Accessory ③: Bluetooth Microphone 
<b>3</b>	FM/AM antenna input 
<b>4</b>	AV Audio output (ø3.5 mini jack)
<b>5</b>	When connecting to an external amplifier, connect its ground wire to the car's chassis to avoid damaging the unit.  <div style="display: flex; align-items: center;"> <div style="margin-right: 10px;">  </div> <div> <p>Rear Audio Preout (Left; White, Right; Red)</p> <p>Front Audio Preout (Left; White, Right; Red)</p> <p>Subwoofer Preout (Left; White, Right; Red)</p> </div> </div>
<b>6</b>	External I/F Maximum power supply current : 12 V $\equiv$ 500 mA

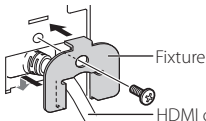
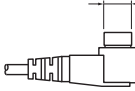
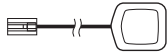
<b>7</b>	HDMI input Use HDMI cable KCA-HD100 (optional accessory). When you connect the cable to HDMI terminal, remove the fixture. After connecting the cable, put the fixture again.  
<b>8</b>	Digital Radio antenna CX-DAB1 (Optional accessory) <b>⚠</b> Use of a CX-DAB1 (optional accessory) as a Digital Radio antenna is recommended. When using a commercially available Digital Radio antenna, the diameter of the SMB connector must be $\Phi 6.5$ mm or less.  
<b>9</b>	Dashboard camera interface Connect a Dashboard Camera DRV-N520 (optional accessory). <b>(P.84)</b>
<b>10</b>	AV Audio input (ø3.5 mini jack)
<b>11</b>	Accessory ⑥: GPS Antenna Use the supplied GPS antenna. Using the GPS antenna other than the supplied one may cause a drop in positioning accuracy.  
<b>12</b>	3rd view camera input (Yellow). See <b>To set up the camera assignment settings (P.48)</b> .
<b>13</b>	Rear view camera input (Yellow)* <sup>1</sup>
<b>14</b>	Front view camera/Dashboard camera input (Yellow). <sup>*2</sup> See <b>To set up the camera assignment settings (P.48)</b> .
<b>15</b>	Video output (Yellow)
<b>16</b>	Video input (Yellow)

\*1 Connect an HD camera to Rear view camera input terminal to use HD video.

\*2 Connect an HD camera to Front view camera/Dashboard camera input terminal to use HD video.

## Securing the USB extension cable

Secure the USB extension cable with insulating tape or the like so that its connectors are not disconnected.

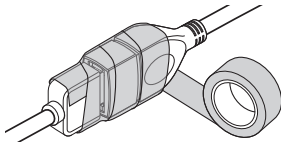

## Connecting a USB device

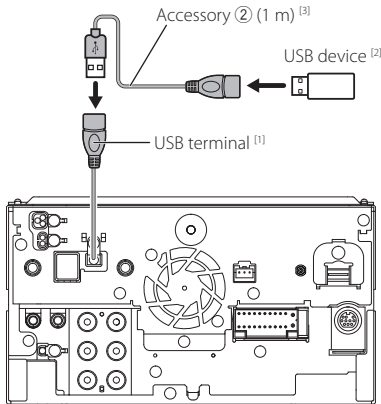

<sup>[1]</sup> USB maximum power supply current :  
DC 5 V  $\overline{\text{---}}$  1.5 A

<sup>[2]</sup> Sold separately

<sup>[3]</sup> See **Securing the USB extension cable (P.83)**.

## Connecting an iPod/iPhone

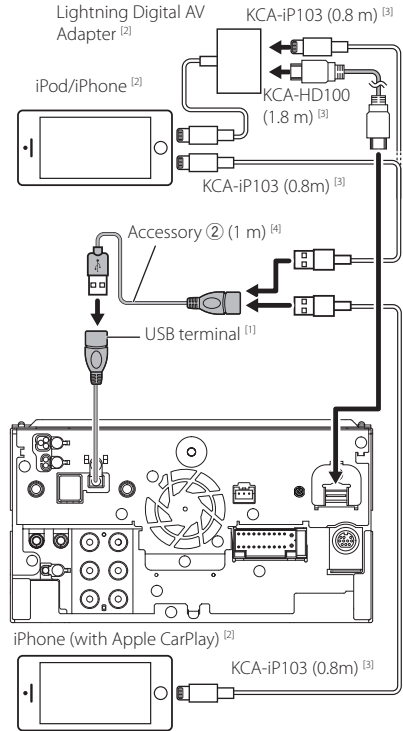

<sup>[1]</sup> USB maximum power supply current :  
DC 5 V  $\overline{\text{---}}$  1.5 A

<sup>[2]</sup> Sold separately

<sup>[3]</sup> Optional accessory

<sup>[4]</sup> See **Securing the USB extension cable (P.83)**.

## Connecting an Android smartphone

Android smartphone (with Android Auto)<sup>[2]</sup>

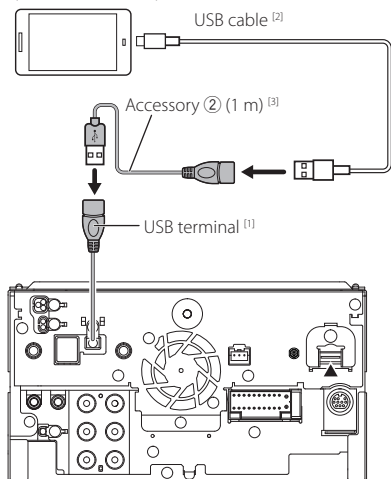

<sup>[1]</sup> USB maximum power supply current : DC 5 V  $\equiv$  1.5 A

<sup>[2]</sup> Sold separately

<sup>[3]</sup> See **Securing the USB extension cable (P.83)**.

## Connecting the camera

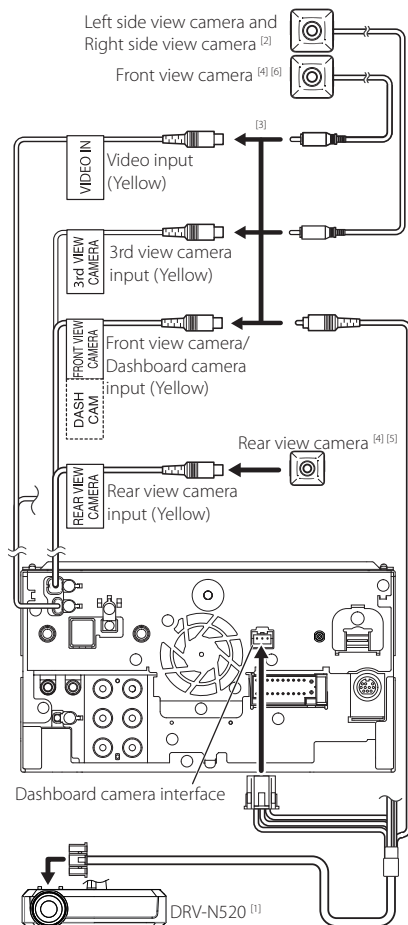

<sup>[1]</sup> Optional accessory

<sup>[2]</sup> Sold separately

<sup>[3]</sup> Up to 3 cameras of Dashboard camera, Front view camera, Left side view camera and Right side view camera can be connected. For details, see **To set up the camera assignment settings (P.48)**.

<sup>[4]</sup> CMOS-3xx series (optional accessory) or commercially available camera.

<sup>[5]</sup> For HD video, an HD camera is also used as Rear view camera.

<sup>[6]</sup> For HD video, an HD camera is also used as Front view camera.

# Troubleshooting

## Problems and Solutions

If any trouble occurs, first check the following table for possible problems.

### NOTE

- Some functions of this unit may be disabled by some settings made on this unit.
- What might seem to be a malfunction in your unit may just be the result of slight misoperation or miswiring.

## About settings

- **Cannot set up the subwoofer.**
- **Cannot set up subwoofer phase.**
- **No output from the subwoofer.**
- **Cannot set up the low pass filter.**
- **Cannot set up the high pass filter.**

Subwoofer is not set to on.

- Set the subwoofer to on. See **Speaker / X'over setup (P.58)**.

The dual zone function is enabled.

- Set the dual zone function to off. See **Zone Control (P.63)**.

- **Cannot select the output destination of the subsource in the dual zone.**
- **Cannot adjust the volume of the rear speakers.**

The dual zone function is disabled.

- Set the dual zone function to on. See **Zone Control (P.63)**.

- **Cannot set up the equalizer.**
- **Cannot set up the crossover network.**

The dual zone function is enabled.

- Set the dual zone function to off. See **Zone Control (P.63)**.

## About audio operations

### Radio reception is poor.

The car antenna is not extended.

- Pull out the antenna all the way.

The antenna control wire is not connected.

- Connect the wire correctly. See **Connecting the system and external components (P.82)**.

### Cannot select a folder.

The random play function is enabled.

- Turn off the random function.

### The unit does not respond when you try to perform a operation during USB mirroring.

- Unplug the smartphone from the USB terminal, then reattach the smartphone again.

## Others

### The Touch Sensor Tone doesn't sound.

The preout jack is being used.

- The Touch Sensor Tone cannot be output from the preout jack.

### Error Messages

When you fail to operate the unit correctly, the cause of the failure appears as the message on the screen.

---

#### **There is an error in the speaker wiring. Please check the connections.**

Protective circuit has been activated because a speaker cord has shorted or it has come in contact with the car chassis.

- Wire or insulate the speaker cord as appropriate and turn the power off and on again.

---

#### **Hot Error**

When the internal temperature of this unit rises to 60°C or more, the protection circuit is activated and you may not be able to operate the unit.

- Use the unit again after reducing the temperature of the unit.

---

#### **Error 07–67**

The unit is not operating correctly due to some reason or other.

- Turn the power off and on again. If the “Error 07–67” message does not disappear, contact your nearest KENWOOD dealer.

---

#### **No Device (USB device)**

The USB device is selected as a source although no USB device is connected.

- Change the source to any source other than USB/iPod. Connect a USB device, and change the source to USB again.

---

#### **Disconnected (iPod, Bluetooth audio player)**

The iPod/Bluetooth audio player is selected as a source although no iPod/Bluetooth audio player is connected.

- Change the source to any source other than iPod/Bluetooth. Connect an iPod/Bluetooth audio player, and change the source to iPod/Bluetooth again.

---

#### **No Media file**

The connected USB device contains no playable audio file. Media was played that does not have data recorded that the unit can play.

- See **Playable Media and Files (P.87)** and try another USB device.

---

#### **USB device over current status detected.**

The connected USB device is rated a current capacity higher than the allowable limit.

- Check the USB device. Some trouble may have occurred to the connected USB device.
- Change the source to any source other than USB. Remove the USB device.

---

#### **The speed sense wire is not connected. Please check the connection.**

The speed pulse disconnection is detected. By default, it is treated as connected.

- To improve precision of a vehicle position recognition, check the connection of the speed pulse.

---

#### **Starting tuner failed.**

The tuner unit is not operating correctly due to some reason or other.

- Turn the power off and on again. If the “Starting tuner failed.” message does not disappear, contact your nearest KENWOOD dealer.

---

### Apple CarPlay

---

#### **The GPS antenna must be connected to use Apple CarPlay wirelessly. Please verify the proper connections or plug in by USB to use Apple CarPlay.**

The GPS antenna is not connected when the Apple CarPlay is started by connecting wirelessly or when the iPhone compatible with wireless Apple CarPlay is registered in **Device List**.

- Check the connection of the GPS antenna or plug in over USB to use Apple CarPlay.

# Appendix

## Playable Media and Files

You can play various kinds of media and files on this unit.

### About files

The following audio and video files are supported.

#### ■ Playable Audio files

	Format	Bit rate	Sampling frequency	Bit count
AAC-LC (.m4a)	MPEG-2/MPEG-4 AAC LC HE-AAC(V1,V2)	8 – 320kbps, VBR	16 – 48 kHz	16 bit
MP3 (.mp3)	MPEG-1/MPEG-2 Audio Layer 3	8 – 320kbps, VBR	16 – 48 kHz	16 bit
WMA (.wma)	Windows Media Audio Standard L3 profile (Version 7,8,9)	8 – 320kbps	16 – 48 kHz	16 bit
Linear PCM (WAVE) (.wav)	RIFF waveform Audio Format	–	16 – 192 kHz	16 bit/24 bit
FLAC (.flac)	flac	–	16 – 192 kHz	16 bit/24 bit
Vorbis (.ogg)	vorbis	–	16 – 48 kHz	16 bit
DSD (.dsf, .dff)	DSF, DSDIFF	–	2.8 MHz, 5.6 MHz, 11.2 MHz	1 bit

- WMA and AAC files with DRM cannot be played.
- DSD sound is converted to PCM sound before playback.
- The EmChinks tag of DSDIFF is not supported.
- Although the audio files complies with the standards listed above, they may not be played depending on the types or conditions of media or device.
- This unit supports playback of High-Resolution Audio files.  
It is recommended that a car audio system should be configured with all High-Resolution Audio compatible products from player to speaker to enjoy its high quality sound.

#### ■ Acceptable Video files

	Profile	Max. Picture size	Max. bit rate	Audio format
MPEG-1 (.mpg, .mpeg)	–	352 × 240, 352 × 288	1.5 Mbps	MPEG Audio Layer 2
MPEG-2 (.mpg, .mpeg)	MP@ML	720 × 480, 720 × 576	8 Mbps	MPEG Audio Layer 2
H.264/MPEG-4 AVC (.mp4, .m4v, .avi, .flv, .f4v)	Baseline Profile, Main Profile	1920 × 1080 (30 fps)	8 Mbps	MP3, AAC
MPEG-4 (.mp4, .avi)	Advanced Simple Profile	1920 × 1080 (30 fps)	8 Mbps	MP3, AAC
WMV (.wmv)	Main Profile	1920 × 1080 (30 fps)	8 Mbps	WMA
MKV (.mkv)	Video format follows H.264/MPEG-4 AVC, MPEG-4, WMV			MP3, AAC, WMA, Vorbis, FLAC

- This unit can only play back files which are smaller than 4 GB.

## Appendix

### ■ Limitation on structure of file and folder

	USB device
Maximum number of folder layers	8
Maximum number of files (per folder)	999
Maximum number of folders (per folder)	9999
Maximum number of folders (per device)	Unlimited

- You can enter a folder name and file name with 255 or fewer single-byte characters.
- Files in the folder whose folder name begins with a dot (.) cannot be played.



## Specifications

### ■ Monitor section

#### Picture Size

- : 10.1 inches (diagonal) wide
- : 223.7 mm (W) × 125.8 mm (H)

#### Display System

- : AAS LCD panel

#### Drive System

- : TFT active matrix system

#### Number of Pixels

- : 2,764,800 (1280H × 720V × RGB)

#### Effective Pixels

- : 99.99 %

#### Pixel Arrangement

- : RGB striped arrangement

#### Back Lighting

- : LED

### ■ USB interface section

#### USB Standard

- : USB 2.0 High Speed

#### File System

- : FAT16, FAT32, exFAT, NTFS

#### Maximum Power Supply Current

- : DC 5 V  1.5 A

#### D/A Converter

- : 24 bit/32 bit

#### Audio Decoder

- : MP3 / WMA / AAC / WAV / FLAC / DSD / Vorbis

#### Video Decoder

- : MPEG-1 / MPEG-2 / MPEG-4 / WMV / H.264 / MKV

#### Frequency Response

- 192 kHz : 20 – 88,000 Hz
- 96 kHz : 20 – 44,000 Hz
- 48 kHz : 20 – 22,000 Hz
- 44.1 kHz : 20 – 20,000 Hz

#### Total Harmonic Distortion

- : 0.010 % (1 kHz)

#### S/N Ratio (dB)

- : 98.5 dB

#### Dynamic Range

- : 89 dB

### ■ Wireless Mirroring section

#### Mode

- : Sink

#### Copyright protection

- : HDCP2.2

#### Touch Control

- : UIBC

### ■ Wi-Fi section

#### IEEE Standard

- : 802.11 a/b/g/n/ac

#### Frequency Range

- : Dual Band (2.4GHz/5GHz)

#### Channels

- : Auto (1-11ch)/Auto (149,153,157,161ch)

#### Transfer rates (MAX)

- : 11a: 54 Mbps / 11b: 11 Mbps / 11g: 54 Mbps / 11n: 300 Mbps / 11ac: 867 Mbps

#### Output Power

##### 2.4 GHz/SISO

- : 11b: 13 dBm ± 2 dB / 11g: 11 dBm ± 2 dB / 11n (20 MHz): 10 dBm ± 2 dB

##### 5 GHz/SISO

- : 11a: 6 dBm ± 2 dB / 11n (20 MHz)/11ac (20 MHz): 6 dBm ± 2 dB / 11n (40 MHz)/11ac (40 MHz): 5 dBm ± 2 dB / 11ac (80 MHz): 5 dBm ± 2 dB

##### 5 GHz/MIMO

- : 11n (20 MHz)/11ac (20 MHz): 9 dBm ± 2 dB / 11n (40 MHz)/11ac (40 MHz): 8 dBm ± 2 dB / 11ac (80 MHz): 8 dBm ± 2 dB

### ■ Bluetooth section

#### Technology

- : Bluetooth Ver.5.0

#### Frequency

- : 2.402 – 2.480 GHz

#### RF Output Power (E.I.R.P.)

- : +4 dBm (MAX), Power Class 2

#### Maximum Communication range

- : Line of sight approx. 10m (32.8 ft)

#### Audio Codec

- : LDAC/SBC/AAC

#### Profile (Multi Profile support)

- HFP (V1.7) (Hands Free Profile)
- SPP (Serial Port Profile)
- A2DP (Advanced Audio Distribution Profile)
- AVRCP (V1.6) (Audio/Video Remote Control Profile)
- PBAP (Phonebook Access Profile)

## Appendix

### ■ HDMI section

#### HDMI

: Type-A

#### Input Resolution

- VGA (640x480p @59.94Hz/60Hz)
- 480p (720x480p @59.94Hz/60Hz)
- 720p (1280x720p @59.94Hz/60Hz)

#### Input Audio Type

: 32K/44.1K/48K/88.2K/96K/176.2K/192K Hz  
16 bit/20 bit/24 bit Linear PCM

### ■ DSP section

#### Graphics equalizer

Band: 13 Band  
Frequency (BAND1 – 13)  
: 62.5/100/160/250/400/630/1k/1.6k/2.5k/4k/6.3k/  
10k/16k Hz

#### Gain

: -9/-8/-7/-6/-5/-4/-3/-2/-1/0/1/2/3/4/5/6/7/8/9 dB

#### 2-way X'Over

##### High pass filter

Frequency: Through, 30/40/50/60/70/80/90/100/  
120/150/180/220/250 Hz  
Slope: -6/-12/-18/-24 dB/Oct.

##### Low pass filter

Frequency: 30/40/50/60/70/80/90/100/120/150/  
180/220/250 Hz, Through  
Slope: -6/-12/-18/-24 dB/Oct.

#### 3-way X'Over

##### High pass filter

Frequency: 250/300/1k/1.6k/2.5k/4k/5k/6.3k/8k/  
10k/12.5k Hz  
Slope: -12/-18/-24 dB/Oct.

##### Band pass filter

Frequency: Through, 50/60/70/80/90/100/120/150/  
180/220/250/300 Hz  
250/300/1k/1.6k/2.5k/4k/5k/6.3k/8k Hz,  
Through

Slope: -12/-18/-24 dB/Oct.

##### Low pass filter

Frequency: 30/40/50/60/70/80/90/100/120/150 Hz,  
Through  
Slope: -12/-18/-24 dB/Oct.

#### Position

##### Front / Rear /Subwoofer Delay

: 0 - 6.1 m (0.01 m Step)

##### Gain

: -8 - 0 dB

#### Subwoofer level

: -50 - +10 dB

### ■ Digital Radio section

#### Frequency Range

BAND III: 174.928 - 239.200 (MHz)

#### Sensitivity

: -100 dBm

#### S/N Ratio (dB)

: 90 dB

### ■ Digital Antenna Connector section

#### Connector type

: SMB

#### Output Voltage (11 - 16V)

: 9.5V DC

#### Maximum Current

: < 100 mA

### ■ FM tuner section

#### Frequency Range (step)

: 87.5 MHz - 108.0 MHz (50 kHz)

#### Usable Sensitivity (S/N : 30 dB)

: 7.3 dBf (0.7  $\mu$ V/75  $\Omega$ )

#### Frequency Response

: 30 Hz - 15 kHz

#### S/N Ratio (dB)

: 70 dB (MONO)

#### Selectivity ( $\pm$ 400 kHz)

: 80 dB

#### Stereo Separation

: 45 dB (1 kHz)

### ■ AM tuner section

#### Frequency Range (step)

LW: 153 - 279 kHz (9 kHz)  
MW: 531 - 1611 kHz (9 kHz)

#### Usable Sensitivity

MW: 30 dB $\mu$  (31  $\mu$ V)  
LW: 34 dB $\mu$  (45  $\mu$ V)

## ■ Video section

Color System of External Video Input

: NTSC/PAL

External Audio Max Input Level (mini jack)

: 2 V/25 k $\Omega$

Video Input Level (RCA jacks)

: 1 V<sub>p-p</sub>/75  $\Omega$

Video Output Level (RCA jacks)

: 1 V<sub>p-p</sub>/75  $\Omega$

Audio Output Level (mini jack)

: 0.9 V/10 k $\Omega$

## ■ Audio section

Maximum Power (Front & Rear)

: 50 W  $\times$  4

Typical Power Output (Front & Rear)

Full Bandwidth Power (at less than 1% THD)

: 22 W  $\times$  4

Output frequency band

: 20 – 88,000 Hz

Preout Level (V)

: 5 V/10 k $\Omega$

Preout Impedance

:  $\leq$  300  $\Omega$

Speaker Impedance

: 4 – 8  $\Omega$

## ■ General

Operating Voltage

: 12 V DC car battery

Installation Dimensions (W  $\times$  H  $\times$  D)

: 178  $\times$  100  $\times$  155 mm

Weight

: 3.25 kg

### NOTE

- Although the effective pixels for the liquid crystal panel is given as 99.99% or more, 0.01% of pixels may not light or may light incorrectly.

**Specifications are subject to change without prior notice.**

## About this Unit

### ■ Important Notice on Software

#### ■ Software License on This Product

The software embedded in this product comprises a number of independent software components, each of which is copyrighted by JVCKENWOOD Corporation or by a third party.

This product uses software components that are based on an End-User License Agreement (hereinafter called "EULA") stipulated by JVCKENWOOD Corporation and by third parties.

The EULA dictates the availability of the source codes of free-software components as a prerequisite to distributing them in executable form under the terms of the GNU General Public License or the Lesser General Public License (hereinafter called "GPL/LGPL"). To get information about the software components that are subject to the terms of the GPL/LGPL, please visit the following Website:

Website URL <https://www2.jvckenwood.com/gpl/>  
Queries concerning the contents of the source code or the like will not be accepted.

Please note that software components based on a EULA that is not subject to the terms of the GPL/LGPL or those that have been developed or created by JVCKENWOOD Corporation will be excluded from the scope of source code disclosure.

Because licenses to use software components distributed under the GPL/LGPL are offered to the customers for free of charge, no warranty is granted to the customers, whether explicitly or implicitly, to the extent of the applicable laws.

Unless otherwise stipulated by the applicable laws or agreed upon in writing, the copyright holders or those who are entitled to modify and redistribute the software components are not held responsible for any and all damages resulting from their use or from inability to use them. For more information about the terms of use of the software components, required items of compliance and so on, please refer to the GPL/LGPL.

Customers wishing themselves to use a software component that is subject to the GPL/LGPL embedded in this product are encouraged to read the terms of the corresponding license before use. Because each individual license is prescribed by a third party other than JVCKENWOOD Corporation, the original (English) of the license is presented.

### ■ EULA

#### ■ Software License Agreement

JVCKENWOOD Corporation (hereinafter called "Licensor") holds either the copyright to the embedded software or the right to sublicense it. This agreement establishes the conditions under which the customer uses this "Licensed Software."

The customer shall agree to the terms of this license agreement before proceeding to use Licensed Software.

This agreement is deemed to have taken effect when the customer (hereinafter called "User") has used a product implementation of Licensed Software.

The Licensed Software may contain software Licensor has been licensed to use by third parties directly or indirectly. Some third parties may have terms of use prescribed for their customers, apart from this Software License Agreement. This agreement does not apply to such software. Be sure to consult "Important Notice on Software" as presented separately.

##### Article 1 (General)

Licensor grants to User a non-exclusive, non-assignable right of use Licensed Software within the country where the User purchases the Product (hereinafter the "Country") (except for the exception provided for in Paragraph 1, Article 3).

##### Article 2 (Right of Use)

1. The rise of use granted under this agreement is the right to use Licensed Software in this product.
2. User may not duplicate, copy, modify, add to, translate or otherwise alter, or loan licensed Software and the associated literature in whole or in part.
3. Use of Licensed Software is limited to a private extent, and Licensed Software may not be distributed, licensed or sublicensed for any purposes whatsoever, including commercial use.
4. User shall use Licensed Software as per the instruction manual or instructions given in the help file and may not use or duplicate data in violation of the regulations of the Copyright Law or other governing laws by using Licensed Software in whole or in part.

##### Article 3 (Terms of License)

1. In assigning this product, User may not retain the original copy of the embedded Licensed Software (including associated literature, updates and upgrades) and any duplicates and associated literature with regard to the license to use Licensed Software. User may transfer Licensed Software only to the condition of binding the assignee to abide by the terms of this Software License Agreement.
2. User may not reverse-engineer, disassemble, decompile or otherwise analyze the source code of Licensed Software.

**Article 4 (Rights to Licensed Software)**

All rights to Licensed Software and the associated literature, including copyrights, shall reside with Licensor or the original right holder who has granted the Right of Use and right to sublicense to Licensor (hereinafter referred to as "Original Right Holder"), and User does not have any rights other than Right of Use granted hereunder with regard to Licensed Software and the associated literature.

**Article 5 (Exemption Granted to Licensor)**

1. Licensor and Original Right Holder do not assume any responsibility for damages caused to User or third parties resulting from the exercise by User of the license granted hereunder, unless otherwise provided by any law to the contrary.
2. Licensor does not warrant Licensed Software to be merchantable, compatible and fit for specific purposes.

**Article 6 (Responsibility for Third Parties)**

If disputes over the infringement of third parties' intellectual property rights, such as copyrights and patent rights, arise out of the use of Licensed Software by User, User shall resolve these disputes at User's own expenses while keep Licensor and Original Right Holder harmless.

**Article 7 (Secrecy Obligation)**

User shall keep confidential Licensed Software provided hereunder, information contained in the associated literature or the like and those provisions of this agreement not yet in public knowledge and may not disclose or leak these to third parties without prior written consent from Licensor.

**Article 8 (Cancellation of the Agreement)**

Licensor reserves the right to cancel this agreement forthwith and claim compensation from User for the damages caused by such cancellation when User:

- (1) Breaches any of the provisions of this agreement, or
- (2) Has received a petition for seizure, provisional seizure, provisional disposition or any other kind of compulsory execution.

**Article 9 (Destruction of Licensed Software)**

If this agreement is terminated under the provision of the foregoing paragraph, User shall destroy Licensed Software, along with all associated literature and its duplicates, within two (2) weeks from the date of termination.

**Article 10 (Copyright Protection)**

1. Copyrights and all other intellectual property rights relating to Licensed Software shall reside with Licensor and Original Right Holder and in no circumstances with User.
2. User shall abide by the laws relating to copyrights and intellectual property rights in using Licensed Software.

**Article 11 (Export Control)**

1. Licensed Software and the associated literature or the like may not be exported to places outside the Country (including transmission outside the Country over the Internet or the like).
2. User agrees that Licensed Software is subject to export controls imposed by the Country and the United States of America.
3. User agrees to comply with all the international and domestic laws that apply to this software (U.S. Export Administration Regulations and regulations established by the U.S., the Country and their governmental agencies regarding usage by end users and export destinations).

**Article 12 (Miscellaneous)**

1. Even if this agreement is invalidated in part by law, all other provisions shall remain in effect.
2. Licensor and User shall consult each other in good faith to resolve any matters not provided for in this agreement or questions arising from the interpretation of this agreement.
3. Licensor and User agree that this agreement is governed by the law of Japan and that all disputes involving claims and obligations that may arise out of this agreement will be settled by arbitration at the Tokyo District Court as the court of first instance.

## ■ Copyrights

- The Bluetooth® word mark and logos are registered trademarks owned by Bluetooth SIG, Inc. and any use of such marks by JVCKENWOOD Corporation is under license. Other trademarks and trade names are those of their respective owners.
- DSD, LDAC and LDAC logo are trademarks of Sony Corporation.
- Hi-Res Audio logo and Hi-Res Audio Wireless logo are used under license from Japan Audio Society.



- Windows Media is a registered trademark or trademark of Microsoft Corporation in the United States and/or other countries.  
This product is protected by certain intellectual property rights of Microsoft. Use or distribution of such technology outside of this product is prohibited without a license from Microsoft.
- This software is based in part on the work of the independent JPEG Group.
- Use of the Made for Apple badge means that an accessory has been designed to connect specifically to the Apple product(s) identified in the badge, and has been certified by the developer to meet Apple performance standards. Apple is not responsible for the operation of this device or its compliance with safety and regulatory standards. Please note that the use of this accessory with an Apple product may affect wireless performance.
- Apple, iPhone, iPod, iPod touch, and Lightning are trademarks of Apple Inc., registered in the U.S. and other countries.
- Apple, Siri, Apple CarPlay, Apple Music and Apple CarPlay logo are trademarks of Apple Inc., registered in the U.S. and other countries.
- App Store is a service mark of Apple Inc., registered in the U.S. and other countries.
- iOS is a trademark or registered trademark of Cisco in the U.S. and other countries and is used under license.
- INRIX is a registered trademark of INRIX, Inc.
- Google, Android, Google Play and Android Auto are trademarks of Google LLC.  
To use Android Auto on your car display, you'll need an Android Auto compatible vehicle or aftermarket stereo, an Android phone running Android 5.0 or higher, and the Android Auto app.
- Wi-Fi® is a registered trademark of Wi-Fi Alliance®.
- The Wi-Fi CERTIFIED™ Logo is a certification mark of Wi-Fi Alliance®.
- Copyright© 2018 Techpoint, Inc. All rights reserved.

HD-TVI™

- The terms HDMI and HDMI High-Definition Multimedia Interface, and the HDMI Logo are trademarks or registered trademarks of HDMI Licensing Administrator, Inc. in the United States and other countries.
- This product includes FontAvenue® fonts licenced by NEC Corporation. FontAvenue is a registered trademark of NEC Corporation.



- This product includes "Ubiquitous QuickBoot TM" technology developed by Ubiquitous Corp. Ubiquitous QuickBoot TM is a trademark of Ubiquitous Corp. Copyright© 2017 Ubiquitous Corp. All rights reserved.  
■ ■ ■ ■ ■  
Ubiquitous
- THIS PRODUCT IS LICENSED UNDER THE AVC PATENT PORTFOLIO LICENSE FOR THE PERSONAL USE OF A CONSUMER OR OTHER USES IN WHICH IT DOES NOT RECEIVE REMUNERATION TO (i) ENCODE VIDEO IN COMPLIANCE WITH THE AVC STANDARD ("AVC VIDEO") AND/OR (ii) DECODE AVC VIDEO THAT WAS ENCODED BY A CONSUMER ENGAGED IN A PERSONAL ACTIVITY AND/OR WAS OBTAINED FROM A VIDEO PROVIDER LICENSED TO PROVIDE AVC VIDEO. NO LICENSE IS GRANTED OR SHALL BE IMPLIED FOR ANY OTHER USE. ADDITIONAL INFORMATION MAY BE OBTAINED FROM MPEG LA, L.L.C. SEE [HTTPS://WWW.MPEGLA.COM](https://www.mpegla.com)
- THIS PRODUCT IS LICENSED UNDER THE MPEG-4 VISUAL PATENT PORTFOLIO LICENSE FOR THE PERSONAL AND NON-COMMERCIAL USE OF A CONSUMER FOR (i) ENCODING VIDEO IN COMPLIANCE WITH THE MPEG-4 VISUAL STANDARD ("MPEG-4 VIDEO") AND/OR (ii) DECODING MPEG-4 VIDEO THAT WAS ENCODED BY A CONSUMER ENGAGED IN A PERSONAL AND NON-COMMERCIAL ACTIVITY AND/OR WAS OBTAINED FROM A VIDEO PROVIDER LICENSED BY MPEG LA TO PROVIDE MPEG-4 VIDEO. NO LICENSE IS GRANTED OR SHALL BE IMPLIED FOR ANY OTHER USE. ADDITIONAL INFORMATION INCLUDING THAT RELATING TO PROMOTIONAL, INTERNAL AND COMMERCIAL USES AND LICENSING MAY BE OBTAINED FROM MPEG LA, LLC. SEE [HTTPS://WWW.MPEGLA.COM](https://www.mpegla.com)
- THIS PRODUCT IS LICENSED UNDER THE VC-1 PATENT PORTFOLIO LICENSE FOR THE PERSONAL AND NON-COMMERCIAL USE OF A CONSUMER TO (i) ENCODE VIDEO IN COMPLIANCE WITH THE VC-1 STANDARD ("VC-1 VIDEO") AND/OR (ii) DECODE VC-1 VIDEO THAT WAS ENCODED BY A CONSUMER ENGAGED IN A PERSONAL AND NON-COMMERCIAL ACTIVITY AND/OR WAS OBTAINED FROM A VIDEO PROVIDER LICENSED TO PROVIDE VC-1 VIDEO. NO LICENSE IS GRANTED OR SHALL BE IMPLIED FOR ANY OTHER USE. ADDITIONAL INFORMATION MAY BE OBTAINED FROM MPEG LA, L.L.C. SEE [HTTPS://WWW.MPEGLA.COM](https://www.mpegla.com)

- libFLAC

Copyright (C) 2000-2009 Josh Coalson  
 Copyright (C) 2011-2013 Xiph.Org Foundation  
 Redistribution and use in source and binary forms, with or without modification, are permitted provided that the following conditions are met:

- Redistributions of source code must retain the above copyright notice, this list of conditions and the following disclaimer.
- Redistributions in binary form must reproduce the above copyright notice, this list of conditions and the following disclaimer in the documentation and/or other materials provided with the distribution.
- Neither the name of the Xiph.org Foundation nor the names of its contributors may be used to endorse or promote products derived from this software without specific prior written permission.

THIS SOFTWARE IS PROVIDED BY THE COPYRIGHT HOLDERS AND CONTRIBUTORS "AS IS" AND ANY EXPRESS OR IMPLIED WARRANTIES, INCLUDING, BUT NOT LIMITED TO, THE IMPLIED WARRANTIES OF MERCHANTABILITY AND FITNESS FOR A PARTICULAR PURPOSE ARE DISCLAIMED. IN NO EVENT SHALL THE FOUNDATION OR CONTRIBUTORS BE LIABLE FOR ANY DIRECT, INDIRECT, INCIDENTAL, SPECIAL, EXEMPLARY, OR CONSEQUENTIAL DAMAGES (INCLUDING, BUT NOT LIMITED TO, PROCUREMENT OF SUBSTITUTE GOODS OR SERVICES; LOSS OF USE, DATA, OR PROFITS; OR BUSINESS INTERRUPTION) HOWEVER CAUSED AND ON ANY THEORY OF LIABILITY, WHETHER IN CONTRACT, STRICT LIABILITY, OR TORT (INCLUDING NEGLIGENCE OR OTHERWISE) ARISING IN ANY WAY OUT OF THE USE OF THIS SOFTWARE, EVEN IF ADVISED OF THE POSSIBILITY OF SUCH DAMAGE.

- libvorbis

Copyright (c) 2002-2008 Xiph.org Foundation  
 Redistribution and use in source and binary forms, with or without modification, are permitted provided that the following conditions are met:

- Redistributions of source code must retain the above copyright notice, this list of conditions and the following disclaimer.
- Redistributions in binary form must reproduce the above copyright notice, this list of conditions and the following disclaimer in the documentation and/or other materials provided with the distribution.
- Neither the name of the Xiph.org Foundation nor the names of its contributors may be used to endorse or promote products derived from this software without specific prior written permission.

THIS SOFTWARE IS PROVIDED BY THE COPYRIGHT HOLDERS AND CONTRIBUTORS "AS IS" AND ANY EXPRESS OR IMPLIED WARRANTIES, INCLUDING, BUT NOT LIMITED TO, THE IMPLIED WARRANTIES OF MERCHANTABILITY AND FITNESS FOR A PARTICULAR PURPOSE ARE DISCLAIMED. IN NO EVENT SHALL THE FOUNDATION OR CONTRIBUTORS BE LIABLE FOR ANY

DIRECT, INDIRECT, INCIDENTAL, SPECIAL, EXEMPLARY, OR CONSEQUENTIAL DAMAGES (INCLUDING, BUT NOT LIMITED TO, PROCUREMENT OF SUBSTITUTE GOODS OR SERVICES; LOSS OF USE, DATA, OR PROFITS; OR BUSINESS INTERRUPTION) HOWEVER CAUSED AND ON ANY THEORY OF LIABILITY, WHETHER IN CONTRACT, STRICT LIABILITY, OR TORT (INCLUDING NEGLIGENCE OR OTHERWISE) ARISING IN ANY WAY OUT OF THE USE OF THIS SOFTWARE, EVEN IF ADVISED OF THE POSSIBILITY OF SUCH DAMAGE.

- libogg

Copyright (c) 2002, Xiph.org Foundation  
 Redistribution and use in source and binary forms, with or without modification, are permitted provided that the following conditions are met:

- Redistributions of source code must retain the above copyright notice, this list of conditions and the following disclaimer.
- Redistributions in binary form must reproduce the above copyright notice, this list of conditions and the following disclaimer in the documentation and/or other materials provided with the distribution.
- Neither the name of the Xiph.org Foundation nor the names of its contributors may be used to endorse or promote products derived from this software without specific prior written permission.

THIS SOFTWARE IS PROVIDED BY THE COPYRIGHT HOLDERS AND CONTRIBUTORS "AS IS" AND ANY EXPRESS OR IMPLIED WARRANTIES, INCLUDING, BUT NOT LIMITED TO, THE IMPLIED WARRANTIES OF MERCHANTABILITY AND FITNESS FOR A PARTICULAR PURPOSE ARE DISCLAIMED. IN NO EVENT SHALL THE FOUNDATION OR CONTRIBUTORS BE LIABLE FOR ANY DIRECT, INDIRECT, INCIDENTAL, SPECIAL, EXEMPLARY, OR CONSEQUENTIAL DAMAGES (INCLUDING, BUT NOT LIMITED TO, PROCUREMENT OF SUBSTITUTE GOODS OR SERVICES; LOSS OF USE, DATA, OR PROFITS; OR BUSINESS INTERRUPTION) HOWEVER CAUSED AND ON ANY THEORY OF LIABILITY, WHETHER IN CONTRACT, STRICT LIABILITY, OR TORT (INCLUDING NEGLIGENCE OR OTHERWISE) ARISING IN ANY WAY OUT OF THE USE OF THIS SOFTWARE, EVEN IF ADVISED OF THE POSSIBILITY OF SUCH DAMAGE.

■ Information on Disposal of Old Electrical and Electronic Equipment and Batteries (applicable for EU countries that have adopted separate waste collection systems)

Products and batteries with the symbol (crossed-out wheeled bin) cannot be disposed as household waste.

Old electrical and electronic equipment and batteries should be recycled at a facility capable of handling these items and their waste byproducts.

Contact your local authority for details in locating a recycle facility nearest to you.

Proper recycling and waste disposal will help conserve resources whilst preventing detrimental effects on our health and the environment.

Notice: The sign "Pb" below the symbol for batteries indicates that this battery contains lead.

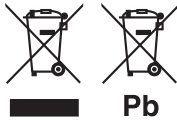

■ מידע בדבר השלכה לאשפה של ציוד חשמלי ואלקטרוני ישן וכן סוללות (רלוונטי למדינות שמשמשות במערכת איסוף אשפה מופרדת).

לא ניתן להשליך מוצרים וסוללות עם הסימון (פח אשפה עם עליו) כאשפה ביתית רגילה.

יש למחזר ציוד חשמלי ואלקטרוני ישן וכן סוללות במתקן המסוגל לטפל בפריטים כאלה ובתוצרי הלוואי שלהם.

צרו קשר עם הרשות המקומית לקבלת פריטים אודות מתקן המיחזור הקרוב אליכם. מיחזור והשלכה לאשפה נאותים יעזרו לשמר משאבים ולמנוע השפעות שליליות על בריאותנו ועל הסביבה.

שימו לב: הסימון Pb שמתחת לסימון עבור סוללות מציינ שהסוללה מכילה עופרת.

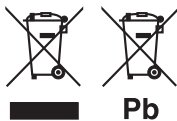

**Declaration of Conformity with regard to the RE Directive 2014/53/EU**

**Declaration of Conformity with regard to the RoHS Directive 2011/65/EU**

**Manufacturer:**

JVCKENWOOD Corporation  
3-12, Moriyacho, Kanagawa-ku, Yokohama-shi,  
Kanagawa 221-0022, JAPAN

**EU Representative:**

JVCKENWOOD Europe B.V.  
Amsterdamseweg 37, 1422 AC UITHOORN, THE  
NETHERLANDS

**English**

Hereby, JVCKENWOOD declares that the radio equipment DMX9720XDS is in compliance with Directive 2014/53/EU. The full text of the EU declaration of conformity is available at the following internet address:

**Français**

Par la présente, JVCKENWOOD déclare que l'équipement radio DMX9720XDS est conforme à la directive 2014/53/UE. L'intégralité de la déclaration de conformité UE est disponible à l'adresse Internet suivante :

**Deutsch**

Hiermit erklärt JVCKENWOOD, dass das Funkgerät DMX9720XDS der Richtlinie 2014/53/EU entspricht. Der volle Text der EU-Konformitätserklärung steht unter der folgenden Internetadresse zur Verfügung:

**Nederlands**

Hierbij verklaart JVCKENWOOD dat de radioapparatuur DMX9720XDS in overeenstemming is met Richtlijn 2014/53/EU. De volledige tekst van de EU-verklaring van overeenstemming is te vinden op het volgende internetadres:

**Italiano**

Con la presente, JVCKENWOOD dichiara che l'apparecchio radio DMX9720XDS è conforme alla Direttiva 2014/53/UE. Il testo integrale della dichiarazione di conformità UE è disponibile al seguente indirizzo internet:

**Español**

Por la presente, JVCKENWOOD declara que el equipo de radio DMX9720XDS cumple la Directiva 2014/53/EU. El texto completo de la declaración de conformidad con la UE está disponible en la siguiente dirección de internet:

**Português**

Deste modo, a JVCKENWOOD declara que o equipamento de rádio DMX9720XDS está em conformidade com a Diretiva 2014/53/UE. O texto integral da declaração de conformidade da UE está disponível no seguinte endereço de internet:

**Polska**

Niniejszym, JVCKENWOOD deklaruje, że sprzęt radiowy DMX9720XDS jest zgodny z dyrektywą 2014/53/UE. Pełny tekst deklaracji zgodności EU jest dostępny pod adresem:

**Český**

Společnost JVCKENWOOD tímto prohlašuje, že rádiové zařízení DMX9720XDS splňuje podmínky směrnice 2014/53/EU. Plný text EU prohlášení o shodě je dostupný na následující internetové adrese:



**Magyar**

JVCケンウッド ezennel kijelenti, hogy a DMX9720XDS rádióberendezés megfelel a 2014/53/EU irányelvnek. Az EU konformitási nyilatkozat teljes szövege az alábbi weboldalon érhető el:

**Hrvatski**

JVCケンウッド ovim izjavljuje da je radio oprema DMX9720XDS u skladu s Direktivom 2014/53/EU. Cjeloviti tekst deklaracije Europske unije o usklađenosti dostupan je na sljedećoj internet adresi:

**Svenska**

Härmed försäkras JVCケンWOOD att radioutrustningen DMX9720XDS är i enlighet med direktiv 2014/53 / EU. Den fullständiga texten av EU-försäkran om överensstämmelse finns på följande Internetadress :

**Suomi**

JVCケンWOOD julistaa täten, että radiolaitte DMX9720XDS on direktiivin 2014/53/EU mukainen. EU-vaatimustenmukaisuusvakuutus löytyy kokonaisuudessaan seuraavasta internet-osoitteesta:

**Slovensko**

S tem JVCケンWOOD izjavlja, da je radijska oprema DMX9720XDS v skladu z Direktivo 2014/53/EU. Celotno besedilo direktive EU o skladnosti je dostopno na tem spletnem naslovu:

**Slovensky**

Spoločnosť JVCケンWOOD týmto vyhlasuje, že rádiové zariadenie DMX9720XDS vyhovuje smernici 2014/53/EÚ. Celý text EÚ vyhlásenia o zhode nájdete na nasledovnej internetovej adrese:

**Dansk**

Herved erklærer JVCケンWOOD, at radioustyret DMX9720XDS er i overensstemmelse med Direktiv 2014/53/EU. EU-overensstemmelseserklæringens fulde ordlyd er tilgængelig på følgende internetadresse:

**Norsk**

JVCケンWOOD erklærer herved at radioustyret DMX9720XDS er i samsvar med Direktiv 2014/53/EU. Den fullstendige teksten til EU-konformitetserklæringen er tilgjengelig på følgende internetadresse:

**Ελληνικά**

Με το παρόν, η JVCケンWOOD δηλώνει ότι ο ραδιοεξοπλισμός DMX9720XDS συμμορφώνεται με την Οδηγία 2014/53/ΕΕ. Το πλήρες κείμενο της δήλωσης συμμόρφωσης της ΕΕ είναι διαθέσιμο στην ακόλουθη διεύθυνση στο διαδίκτυο:

**Eesti**

Käesolevaga JVCケンWOOD kinnitab, et DMX9720XDS raadiovarustus on vastavuses direktiiviga 2014/53/EL. ELi vastavusdeklaratsiooni terviktekst on kätesaadav järgmisel internetiaadressil:

**Latviešu**

JVCケンWOOD ar šo deklarē, ka radio aparatūra DMX9720XDS atbilst direktīvas 2014/53/ES prasībām. Pilns ES atbilstības deklarācijas teksts ir pieejams šādā tīmekļa adresē:

**Lietuviškai**

Šiuo JVCケンWOOD pažymi, kad radijo įranga DMX9720XDS atitinka 2014/53/EB direktyvos reikalavimus. Visą EB direktyvos atitikties deklaracijos tekstą galite rasti šiuo internetiniu adresu:

**Malti**

B'dan, JVCケンWOOD jiddikjara li t-tagħmir tar-radju DMX9720XDS huwa konformi mad-Direttiva 2014/53/UE. It-test kollu tad-dikjarazzjoni ta' konformità huwa disponibbli fl-indirizz intranet li gej:

**Українська**

Таким чином, компанія JVCケンWOOD заявляє, що радіообладнання DMX9720XDS відповідає Директиві 2014/53/ЕУ. Повний текст декларації про відповідність ЄС можна знайти в Інтернеті за такою адресою:

**Türkçe**

Burada, JVCケンWOOD DMX9720XDS radyo ekipmanının 2014/53/AB Direktifine uygun olduğunu bildirir. AB uyumluluk deklarasyonunun tam metni aşağıdaki internet adresinde mevcuttur.

**Русский**

JVCケンWOOD настоящим заявляет, что радиооборудование DMX9720XDS соответствует Директиве 2014/53/ЕУ. Полный текст декларации соответствия ЕС доступен по следующему адресу в сети Интернет:

**Limba română**

Prin prezenta, JVCケンWOOD declară că echipamentul radio DMX9720XDS este în conformitate cu Directiva 2014/53/UE. Textul integral al declarației de conformitate UE este disponibil la următoarea adresă de internet:

**Български език**

С настоящото JVCケンWOOD декларира, че радиооборудването на DMX9720XDS е в съответствие с Директива 2014/53/ЕС. Пълният текст на ЕС декларацията за съответствие е достъпен на следния интернет адрес:

**URL: <https://www.kenwood.com/cs/ce/eudoc/>**

---

**KENWOOD**