



OWNER'S MANUAL
8000.1EVO5

Introduction	3
Package contents	3
Safety instructions	4
Assembling and disassembling the plastic cover	5
Panels description	
Audio inputs and controls	6
Power inputs and audio outputs	7
Installation sequence	8
Electrical dimensioning	9
Audio inputs	
RCA inputs	9
High Level inputs	9
Wiring diagram	10
SD RLC and procedure for setting the gain	11
Bass Boost set up	12
Crossovers set up	12
Battery connection diagram	13
Amplifier operational LEDs	14
Diagnostic table	15
Technical specifications	
Parameters	16
Dimensional data	16
Additional Information	16

Dear Consumer,

Congratulations, you have just acquired a SounDigital product of the highest technology and quality, so we thank you for your trust.

SounDigital products are made with raw materials of the highest quality standards, and the most modern processes, equipment and technology are used in their production.

IMPORTANT INFORMATION

On this manual you will learn about the product, its features and characteristics, in order to obtain the best result and to be able to enjoy your music with SounDigital quality and power.

Read this manual carefully and follow precisely all the information contained therein, these are very important and allow your amplifier to work optimally. If you think it is necessary, please do not hesitate to contact our technical support at the following contact:







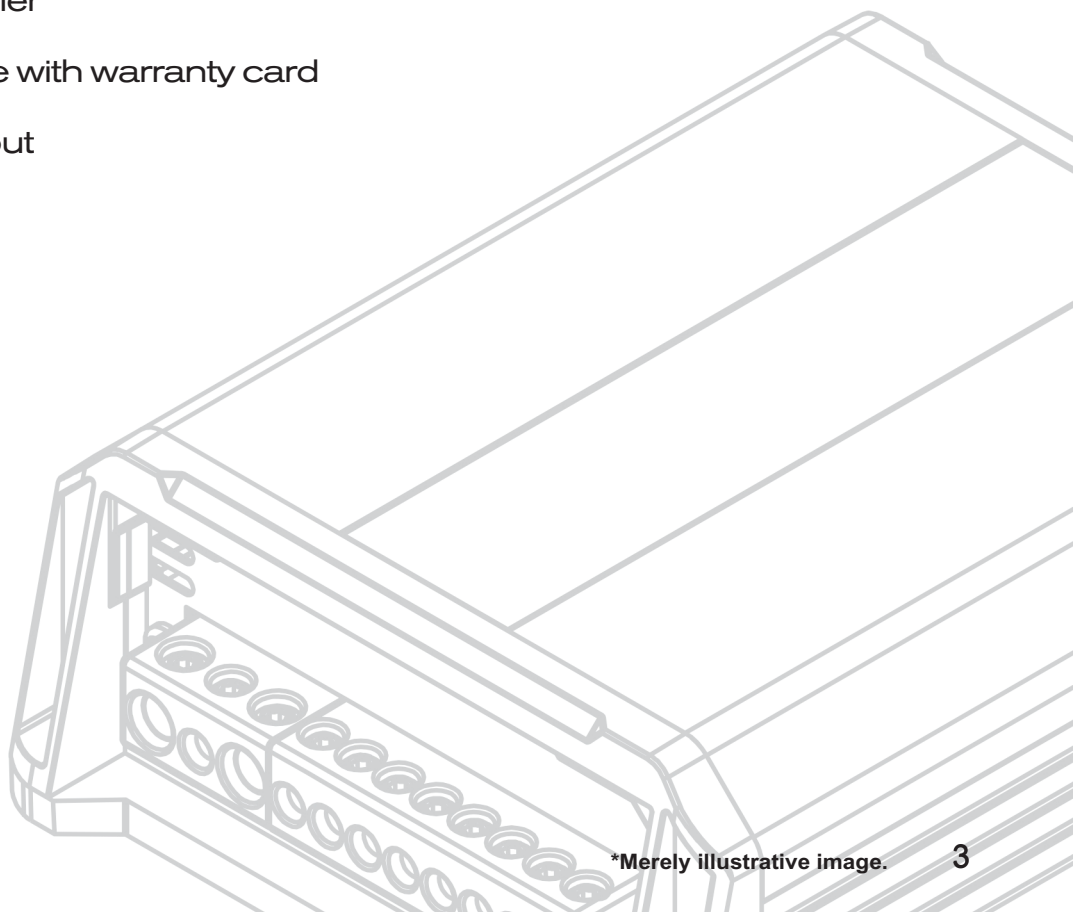

✉ info@soundigitalusa.com

PACKAGE CONTENTS

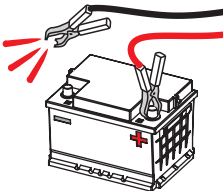
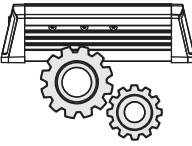
- 01 **8000.1 EVO5** Amplifier
- 01 Installation quick guide with warranty card
- 01 Cable for high level input
- 01 Promotional sticker

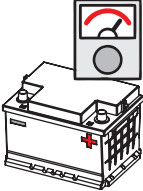
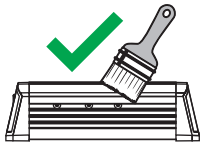

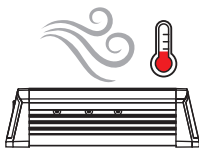
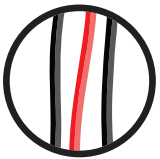
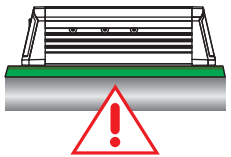
To avoid injury to the user or damage to the amplifier, read all safety instructions written on this manual.

<p>The installation of this product must be done by a qualified professional. In case of any doubt, please contact our technical support;</p>		 <p>When passing cables through metallic walls, use rubber O-rings to avoid cable cutting and short-circuits;</p>
<p>Before proceeding with the installation of any electric equipment on your vehicle, unplug the negative (-) terminal of the battery to avoid fires, injuries or damages;</p>		 <p>Make sure that the chosen location for the amplifier installation does not affect the operation of the vehicle;</p>
<p>Use your sound system safely. The continuous exposure to sound pressures over 85dB may cause irreversible hearing damage;</p>		 <p>This product may reach temperatures over 60°C (140°F). Make sure it is cold before touching it;</p>
<p>This equipment is for use in automotive DC voltage batteries between 12.6 and 14.4 volts. Before installing the equipment, check voltage of the batteries;</p>		 <p>Clean the amplifier periodically with brush or dry cloth to assure the thermal efficiency of the heatsink;</p>
<p>Do not install the amplifier in places exposed to water, dirt or humidity;</p>		 <p>Be careful when making holes in the vehicle. Make sure you are not making holes in the fuel tank, brake lines or electrical cables of the vehicle;</p>
<p>Choose a ventilated place to install the amplifier and avoid blocking the side ventilation windows;</p>		 <p>Make sure the cables are properly secured throughout the installation;</p>
<p>Fix the amplifier properly and firmly. Avoid fixing to metallic parts of the vehicle, as this procedure may cause ground looping (noise);</p>		 <p>Wear gloves, safety glasses and all necessary PPE during the installation of Soundigital amplifiers.</p>



Warning!

THIS "WARNING" SIGN ALERTS THE USER OF IMPORTANT INFO. NOT FOLLOWING THESE INSTRUCTIONS MAY CAUSE INJURIES TO THE USER OR DAMAGE TO THE EQUIPMENT.

The plastic covers are used to finish off and hide the amplifier's fixing screws. To disassemble and assemble them, follow the instructions below.

DISASSEMBLING OF THE PLASTIC COVER

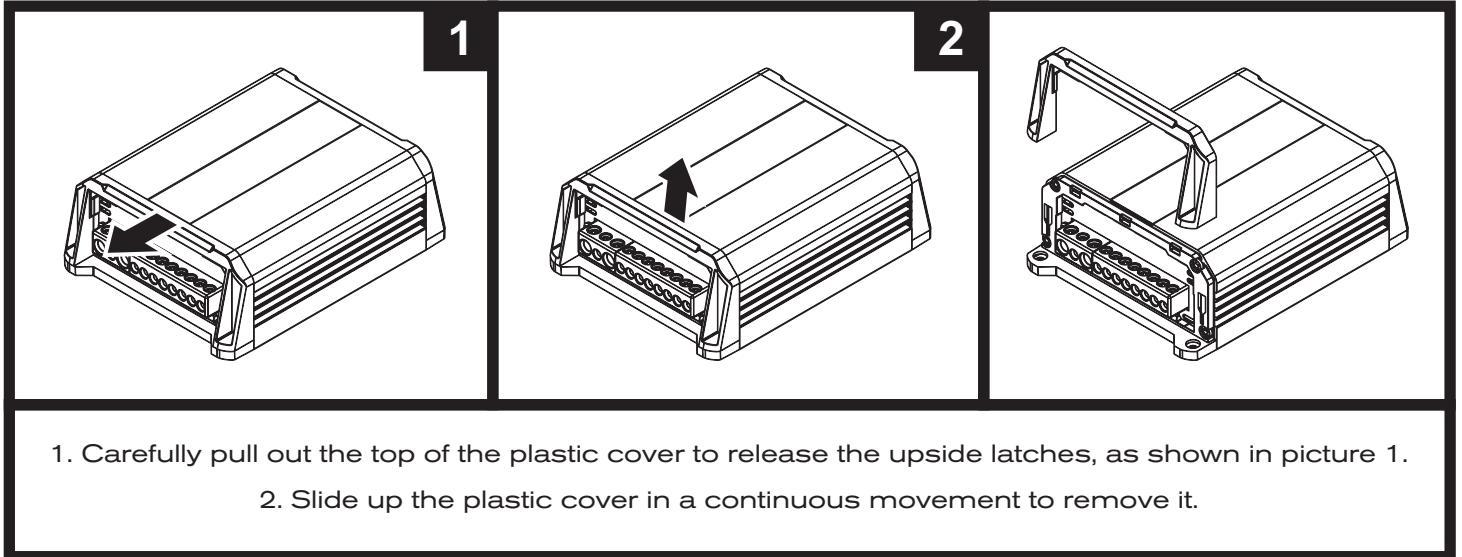

*Merely illustrative images.

ASSEMBLING THE PLASTIC COVER

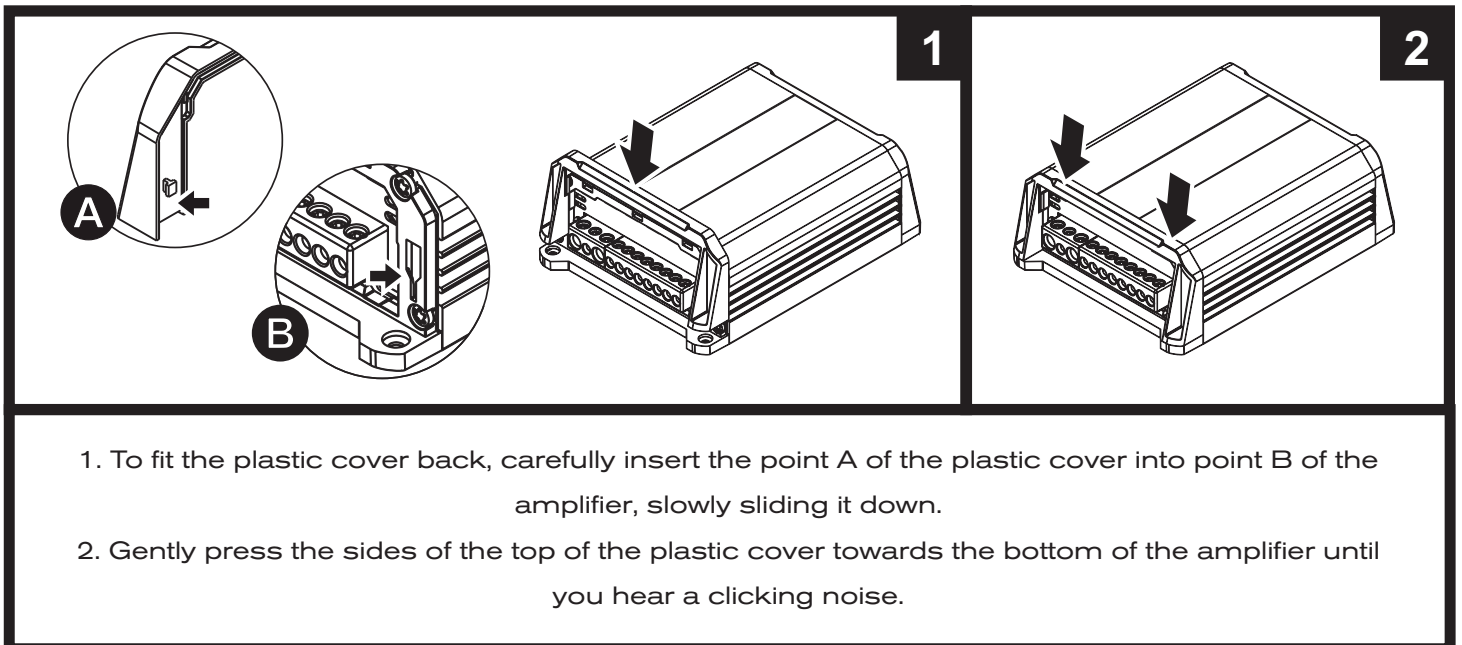

*Merely illustrative images.

Audio inputs and controls

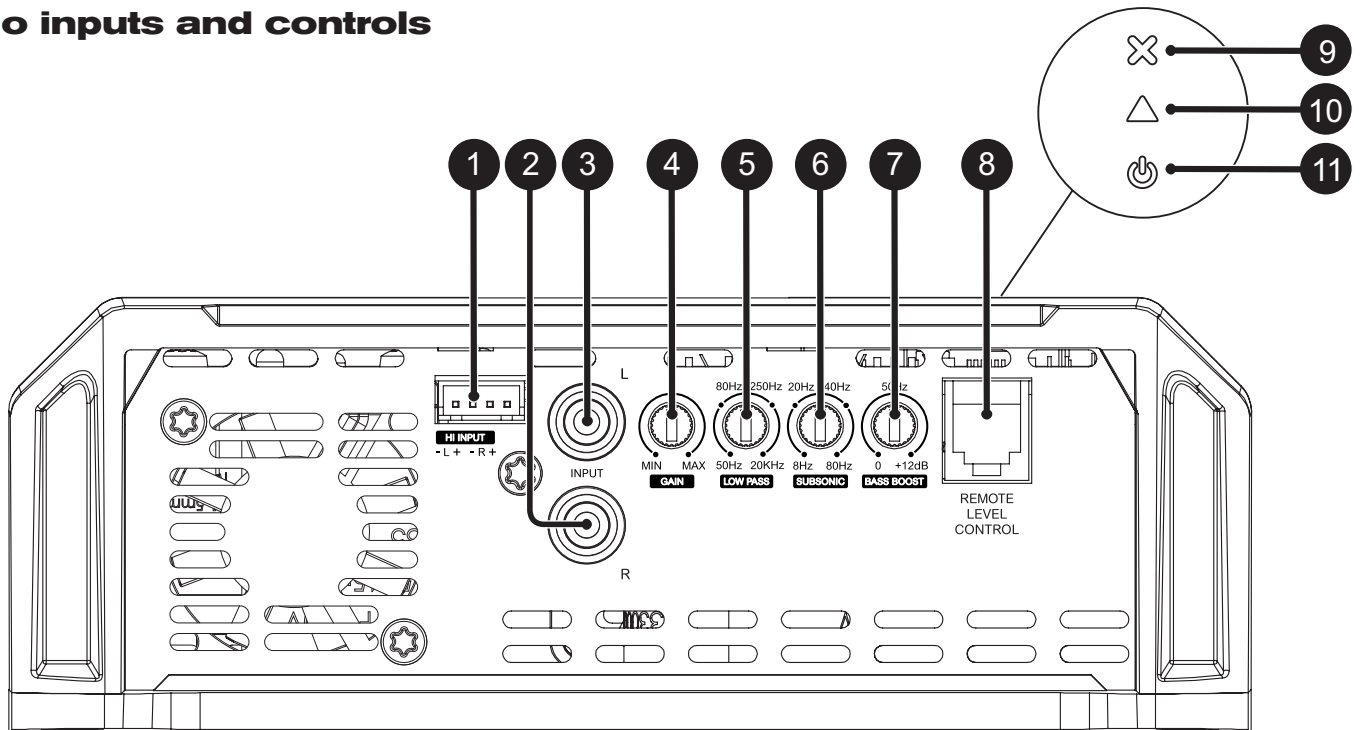

1	Right Channel Left Channel	Audio input – High Level (To connect to the speaker output of the head unit)
2	Right Channel	Audio inputs – RCA connectors
3	Left Channel	
4	-	Variable Gain Control
5	-	Variable "LOW PASS" filter control (50Hz ~ 20kHz)
6	-	Variable "SUBSONIC" filter control (8Hz ~ 80Hz)
7	-	Variable "BASS BOOST" control 50Hz (0dB ~ +12dB)
8	-	Remote level control connector
9	Red	"PROTECTION" LED indicator
10	Yellow	"CLIP" LED indicator
11	Blue	"POWER ON" LED indicator

Power inputs and audio outputs

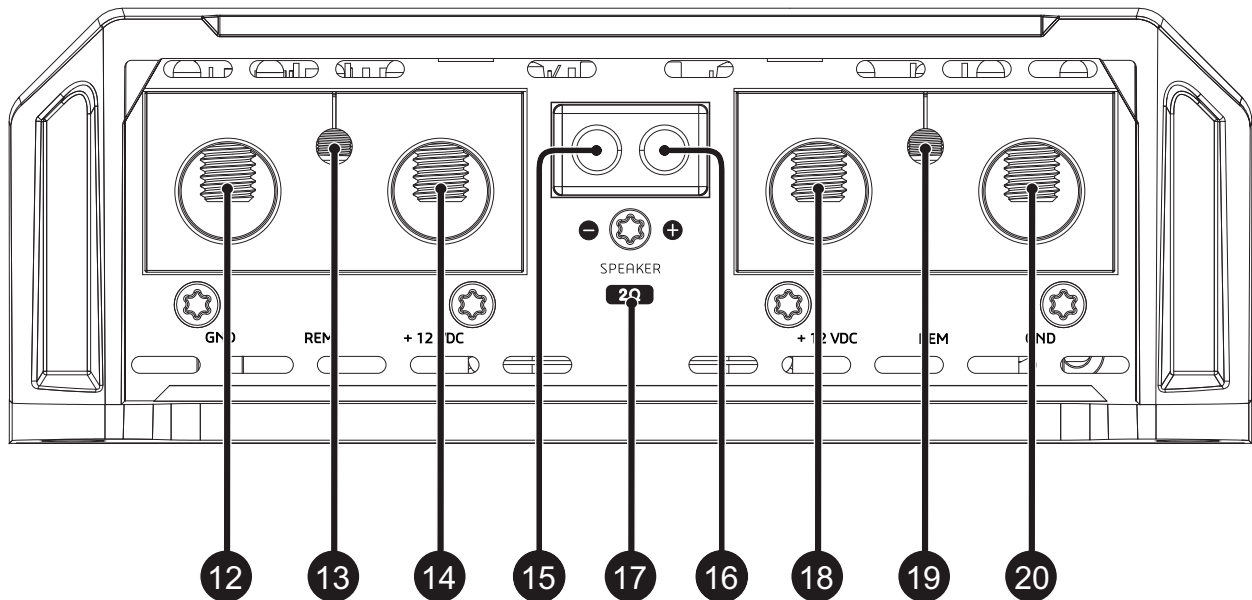

12	-	Negative power supply connector (GND)
13	-	Remote power supply connector (REM)
14	-	Positive power supply connector (+12VDC)
15	Speaker Output Connectors	Negative speaker connector (-)
16		Positive speaker connector (+)
17	-	Minimum speaker load allowed (impedance)
18	-	Positive power supply connector (+12VDC)
19	-	Remote power supply connector (REM)
20	-	Negative power supply connector (GND)

**Warning!**

BEFORE PROCEEDING WITH THE INSTALLATION, UNPLUG THE NEGATIVE TERMINAL FROM ALL OF THE BATTERIES, TO AVOID FIRE, DAMAGE TO THE AMPLIFIER AND THE USER HIMSELF.

- Fix the amplifier so that the connectors can be easily accessed;
- Install the power cables in the vehicle properly, starting from the battery to the fuse holder or circuit breaker, use the cable with the appropriate size. Make all connections, install fuse holders or circuit breakers, but without placing the fuses or with the circuit breakers in the "OFF" position;

**Warning!**

THE MAXIMUM DISTANCE FOR THE INSTALLATION OF THE FUSE/CIRCUIT BREAKER IS 12 INCHES (30cm) AWAY FROM THE BATTERY.

- Connect the power cables in to the amplifier, observing the polarity. Connect all the positive cables (+) from the fuse holder or circuit breaker to the positive conector of the amplifier and all the negative power cables from the batteries to the negative connector of the amplifier;
- The ground cable must be as short as possible and must be connected to the vehicle chassis and the battery negative;

Remove the paint
between the terminal
and chassis

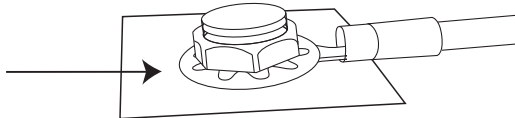

- Install the signal input cables in a proper way, distant from the power cables;
- Connect the RCA or the high level signal input cables to the head unit and amplifiers;
- Install the audio output cables with the appropriate section, distant from the power and audio input cables;
- Connect the audio output cables to the amplifier and speakers respecting the positive (+) and negative (-) polarities;
- Install the remote cable with the power cables, using 1.5mm² (15 AWG) cable or thicker;
- Connect the remote power cable to the amplifier's "REM" terminal at the main unit's remote power output (when not using the high level signal inputs);
- Before powering the system, verify all the connections and make sure there are no mistakes or short-circuits on the power and ground cables;
- Reconnect the ground of the batteries;
- Check if the head unit is turned off and then place the fuses in the fuse holders or switch the circuit breakers on;
- Turn on the main unit and the amplifier will turn on the "POWER ON" LED indicating that it is in operation.

**Warning!**

Minimum recommended
installation distance
between amplifiers*.
1.18in. (30mm)

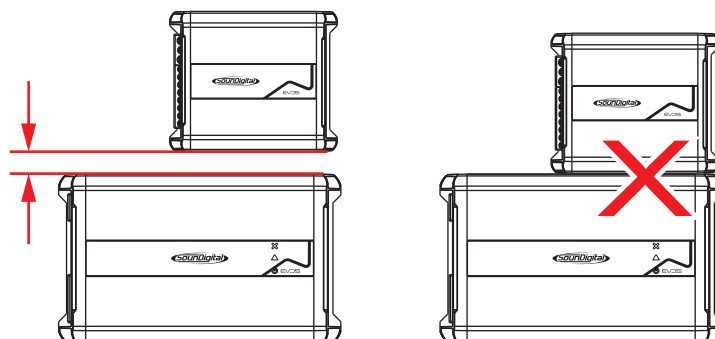

*For installations with more than one amplifier, second unit not included. Merely illustrative images.

ELECTRICAL DIMENSIONING

For proper operation of your SounDigital amplifier, you need the proper dimensioning of the electrical system and the cables used.

The table below shows the minimum section of GND cables, +12VDC cables and speaker output cables according to the power generated by the amplifier.

8000 WRMS	POWER CABLE (+12VDC)	70mm ² (00 AWG)
	GROUND CABLE (GND)	
	SPEAKER CABLE	2 x 10mm ² (7 AWG)

We recommend the use of only OFC (Oxygen Free Copper) cables on the installation of our products.

Copper-clad aluminum wire (CCAW) must not be used.

AUDIO INPUTS

RCA inputs

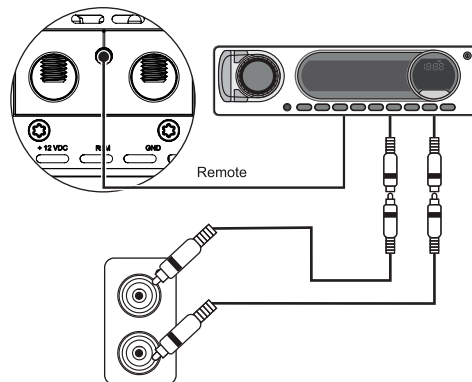

All RCA inputs must be connected for the amplifier to work properly.

High level signal inputs

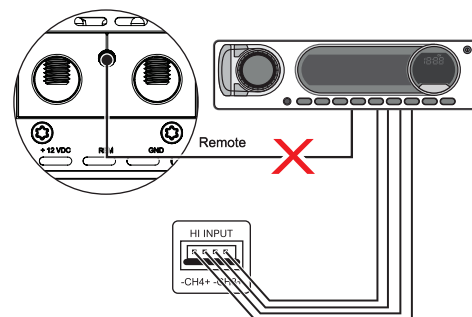

All High level signal inputs must be connected for the amplifier to work properly.

High level input must be used when the main unit does not have RCA outputs.

When High level input is used, no remote connection is required, the amplifier recognizes the audio signal and switches on.

If your source unit is not able to turn on the amplifier through the High level input, the remote input should be connected normally.



Warning!

RCA AND HIGH LEVEL INPUTS SHOULD NOT BE USED SIMULTANEOUSLY OR YOU MAY DAMAGE THE AMPLIFIER.



Unplug the negative (-) terminal of the battery before proceeding with any electrical installation in the vehicle to avoid fire starts, wounds or damage to the amplifier.

POWER CONNECTIONS

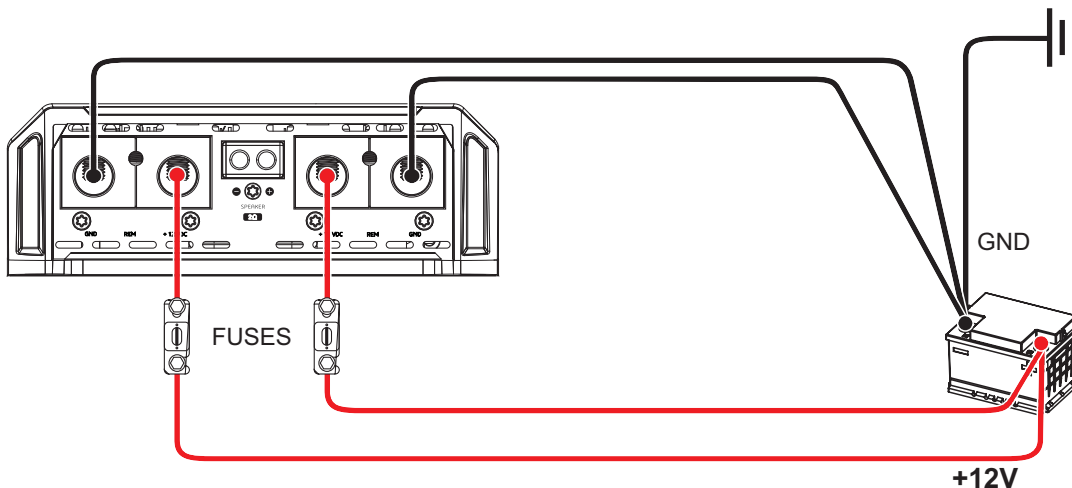

REMOTE INPUT CONNECTIONS

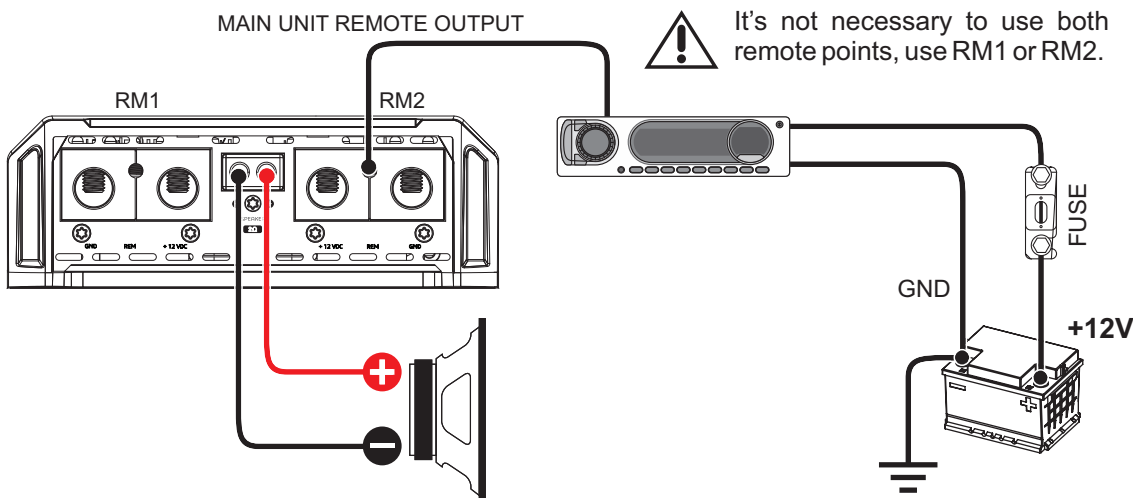

It's not necessary to use both remote points, use RM1 or RM2.

AUDIO INPUT AND OUTPUT CONNECTIONS



All RCA must be connected for the amplifier to function properly.

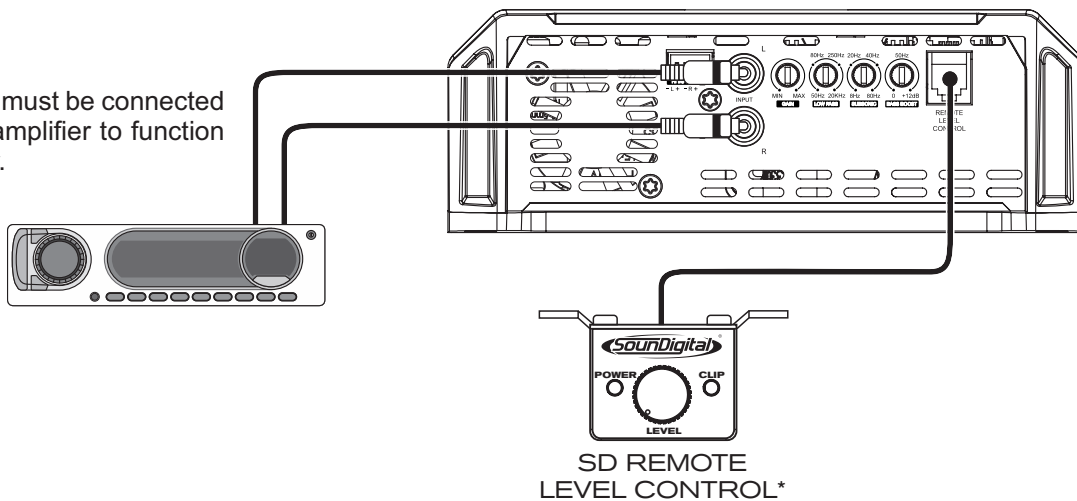

SD REMOTE LEVEL CONTROL*

*Sold separately

EXTERNAL LEVEL CONTROL - SD RLC (*NOT INCLUDED)

The SD RLC is an easy-to-install external level control accessory that allows you to tune the level of SOUNDIGITAL amplifiers that have remote level control.

In SD RLC, you can adjust the amplifier level without having to lean over and adjust the gain setting on the amplifier and can monitor the "CLIP" LED which is also available on the accessory.

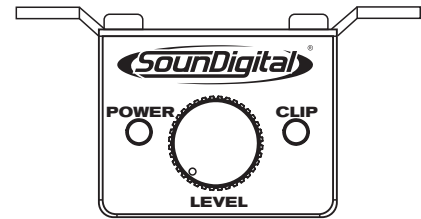

SD REMOTE
LEVEL CONTROL*

*Sold separately

GAIN SETTING

Necessary equipment:

- Digital AC voltmeter;
- Media with sine wave test tone 60Hz recorded at 0db;
- Screwdriver 1/8" (for gain set).
- Set the source unit's fader control to center position;
- Set the variable "LOW PASS" crossover in 20kHz and the "SUBSONIC" in 8Hz;

Set up procedure

- Turn the gain control all the way down;
- Disconnect the output cables from the amplifier outputs;
- Turn off all processing (bass, treble, loudness, EQ, etc.);
- Set the source unit volume to 3/4 of full volume;
- Use a 60 Hz sine wave;
- Increase the gain control until the "CLIP" LED starts blinking;
- Return the gain to the limit where the "CLIP" LED stops blinking and remains off;
- Once you have adjusted the amplifier to the correct voltage output, turn off the source unit and reconnect the speaker(s).

Download the tracks for set up in <https://sounddigitalusa.com/tracks-for-set-up/>

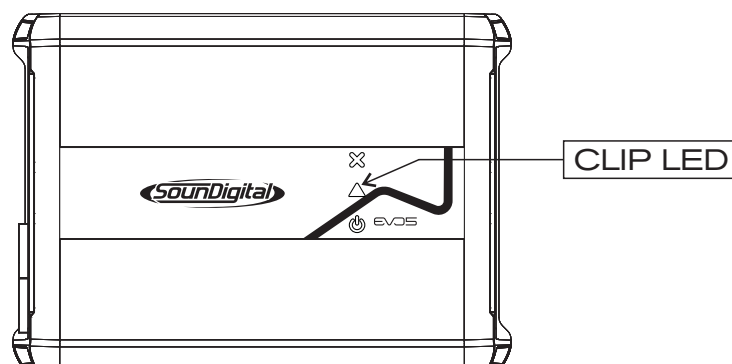

Using Bass Boost

The Amplifier Bass Boost setting enables the user to boost the sound intensity at low frequencies of the sound system, where boost intensity can be adjusted.

This is a semi-parametric equalizer type circuit with "Q" value for the fixed filter, with an intensity boost adjustment from 0 to +12dB (16 times), and a central frequency adjustment of the filter in 50Hz, making it versatile for several types of sound systems.

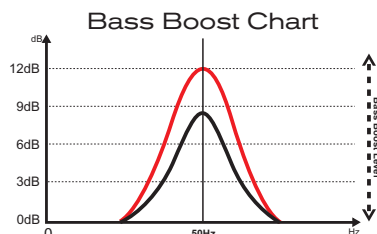

How to Adjust Bass Boost

Reproduce your favorite song and set the boost intensity between 0dB and +12dB at the variable control level according your preference.

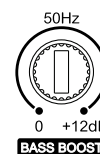

How to Adjust the Crossovers

The use of the two associated filters can form a bandpass filter, as in the figure below, where the point "A" is defined in the "SUBSONIC" crossover and the point "B" is defined in the "LOW PASS" crossover.

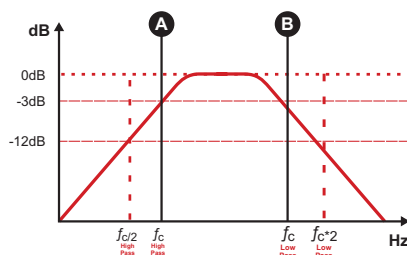
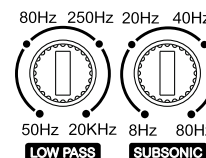

To set the "SUBSONIC" variable control between 8Hz and 80Hz ("A") where you want to perform the subsonic cut filter;

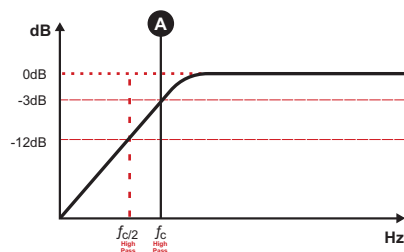

Set in the "LOW PASS" variable control between 50Hz and 20kHz ("B") where you want to perform the low pass cut filter;

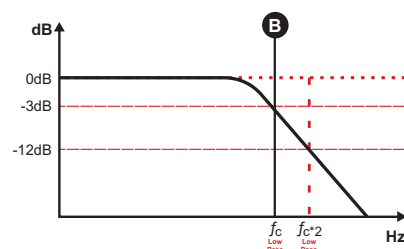

 **"POWER" LED indicator (blue)**
LED "POWER" Off..... Product off.

 **"CLIP" LED indicator (yellow)**
LED "CLIP" Off Product operating normally.
LED "CLIP" Flashing..... Audio distortion indication.

 **"PROTECTION" LED indicator (red)**
LED "PROTECTION" Off..... Product operating normally.

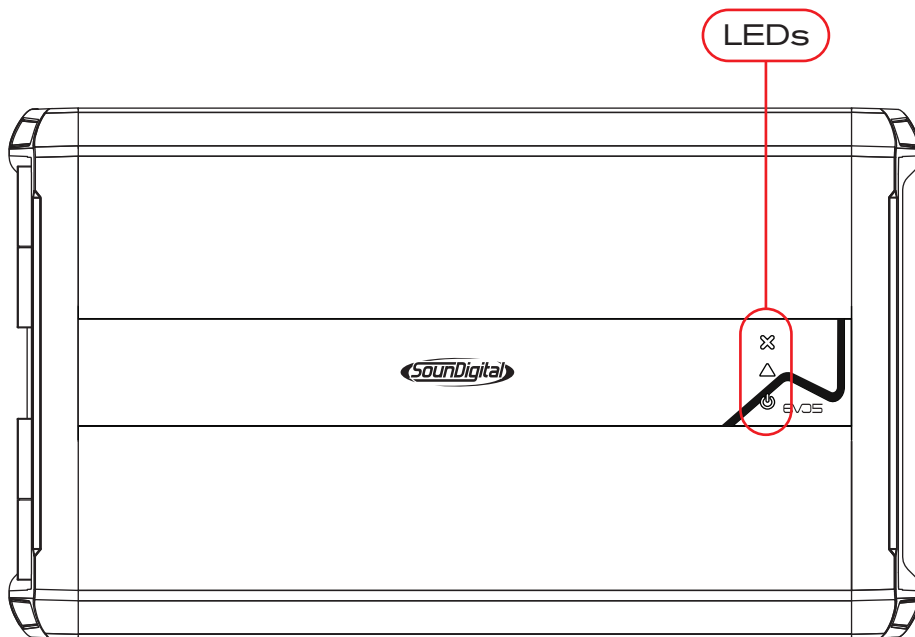

In the vast majority of cases, situations that at first glance appear to be a defect can be adjusted and resolved by yourself without the need to seek Authorized SoundDigital Technical Assistance. If the problem persists after carrying out the corrective actions below, contact our nearest technical team.

APPARENT DEFECT	PROBABLE CAUSE	SOLUTION
Amplifier does not turn on.	Lack of power supply.	•Check if the power and remote signal cables are connected correctly.
When audio is cut off, the blue LED flashes.	Low or very high supply voltage.	•Check the battery, cables and fuse holder of the installation.
When audio is cut off and the yellow LED remains flashing.	Low impedance at the amplifier output terminals.	•Check if there is a short circuit in the output wiring or if there is a short circuit in any speaker. •Check the minimum recommended impedance for the equipment.
When audio is cut off and the red LED remains on.	Temperature protection.	•Check whether the amplifier has obstructed ventilation inlets or is exposed to sunlight. •Check that the minimum connection impedance has been respected. •Keep the amplifier turned on until it reaches normal operating temperature and audio is restored.
Red LED flashes before the yellow one or in sync with the music.	Undersized battery or cables.	•Check that the battery and cables are sized as specified in the parameter table in this manual.
Abnormal noise from the speakers.	Ground fault.	•Check if there is a defective RCA cable, if the radio's RCA ground is open or if there is an external power source connected (source or charger). •Make sure the RCA cables are close to the vehicle's power cables or wiring harnesses. •Check that the vehicle's spark plug wires are suppressive. In many cases it is necessary to use capacitors in the alternator, horn and ignition. •Check the quality of the grounding and that there is no paint at the fixing point, if necessary, scrape it off. For fixing, use an eye terminal correctly sized for the cable. When using other amplifiers, ground each piece of equipment at the same point.
Popping noise in speakers when amplifier is turned on or off.	RCA ground fault.	•Check whether the car radio's RCA grounding or the RCA cable's grounding mesh are broken.
Weak bass.	Phase cancellation between speakers.	•Check if there is a reversal in the polarity of the connection between the speakers.
Amplifier turns on but there is no audio.	Input or output connection failed or no signal.	•Check the connection of the RCA cables and output cables. •Check the car radio volume, balance or fader settings and audio processor levels.

PARAMETERS	8000.1 EVOS 1Ω	8000.1 EVOS 2Ω
Power RMS @ 4Ω**	3844W	5360W
Power RMS @ 2Ω**	5360W	8000W
Power RMS @ 1Ω**	8000W	N/A
Frequency Response (-3dB)	8Hz ~ 20kHz	8Hz ~ 20kHz
Low Pass filter (12dB/oct)	50Hz ~ 20kHz	50Hz ~ 20kHz
Subsonic (12dB/oct)	8Hz ~ 80Hz	8Hz ~ 80Hz
Bass Boost	0dB ~ 12dB @ 50Hz	0dB ~ 12dB @ 50Hz
Operating Voltage	9V ~ 16V	9V ~ 16V
SNR	92dB	85dB
Input Sensitivity (RCA)	0.2V ~ 2V	0.2V ~ 2V
Input Sensitivity (High Level input)	1.3V ~ 15V	1.3V ~ 15V
Current Draw (music)	381A	381A
Current Draw (max.)	762A	762A
Total Efficiency	80%	80%
Damping Factor (@100Hz nominal impedance)	>2000	>2000
Power Cable	70mm ² (00 AWG)	70mm ² (00 AWG)
Speaker Cable	2 x 10mm ² (7 AWG)	2 x 10mm ² (7 AWG)
Remote Cable	1.5mm ² (15 AWG)	1.5mm ² (15 AWG)
Recommended Fuse* (music)	2 x 200A	2 x 200A
Recommended battery (minimum)	400Ah	400Ah

*It is mandatory to install the fuse at a maximum distance of 12 inches from the battery.

**Power at 12.6V @ 60Hz with a maximum THD of 1%.



****POWER RATING ACCORDING TO CTA-2006 INDUSTRY STANDARDS**

DIMENSIONAL DATA

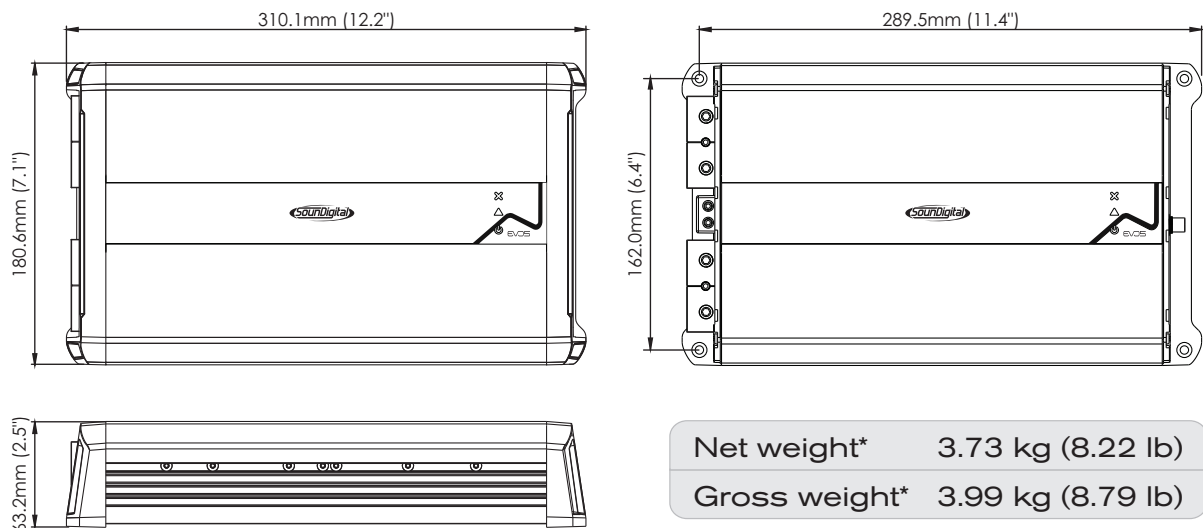

Net weight* 3.73 kg (8.22 lb)

Gross weight* 3.99 kg (8.79 lb)

*Weights may vary slightly depending on the manufacturer.

ADDITIONAL INFORMATION

The values presented are based on measurements performed in SounDigital's laboratories. All the equipment used in the assays, tests, measurements and gauging of the technical parameters of SounDigital products were calibrated in certified laboratories, thus ensuring the performance and standard of excellence of the developed products.

The Manufacturing Process may present variations, and the electronic components may also present changes in values in relation to their nominal parameters. Thus, causing small differences between measurements taken. Small variations in the values presented and divulged by SounDigital are recognized.



Updates of information made in this document will always be published and made available for consumer consultation, free of charge, on the brand's websites. The user is advised to search for the manual in its latest version when necessary.

The images presented in this document are representative and merely illustrative; therefore, they do not necessarily correspond to the actual product/model.



YOUR MUSIC. **YOUR POWER.**

Document revision code: 1000750395-005/JUN2024



Consumer
Technology
Association™



WWW.SOUNDIGITALUSA.COM



[SOUNDIGITALUSA](https://www.facebook.com/SOUNDIGITALUSA)



[SOUNDIGITALUSA](https://www.instagram.com/SOUNDIGITALUSA)