



YOUR MUSIC. **YOUR POWER.**

The 35000.1 EVOX is designed exclusively for competitions and should not be installed on systems for daily use.

OWNER'S MANUAL
35000.1 EVOX

EVOX

Introduction	3
Package contents	3
Safety instructions	4
Technologies	
Low Bass Correction	5
Ultra Compact PCB.....	5
Vibration Absorption Device	6
I-Power Supply.....	6
Assembling and Disassembling the plastic cover	7
Panels description	
Audio inputs and controls.....	8
Power inputs and audio outputs.....	9
Electrical Dimensioning	10
RCA inputs	10
Installation sequence.....	11
Gain Setting	12
Bass Boost set up.....	13
Crossovers set up.....	13
Wiring Diagram	14
Technical specs	
Parameters.....	15
Dimensional data	15

DEAR CUSTOMER,**CONGRATULATIONS ON ACQUIRING A PRODUCT WITH THE HIGHEST QUALITY AND TECHNOLOGY!**

You have just purchased a **SoundDigital** product of the highest technology and quality, so we thank you for your confidence.

SoundDigital products are made with raw materials of the highest quality standards, and the most modern processes, equipment and technology are used in their production.

On this manual you will learn about the product, its features and characteristics, in order to obtain the best result and to be able to enjoy your music with **SoundDigital** quality and power.

To better understand and take advantage of all the functions of the product and use it safely, read this manual carefully and if you have any questions, consult our support by email info@sounddigitalusa.com.

PACKAGE CONTENTS

- 01 **35000.1 EVOX** Amplifier
- 01 Installation quick guide with warranty card
- 01 Allen wrench 2.5mm
- 01 Allen wrench 3.0mm
- 01 Allen wrench 4.0mm
- 01 Promotional sticker

**Warning!**

The 35000.1 EVOX is designed exclusively for SPL competitions and should not be installed on systems for daily use.

To prevent injuries to the user or damage to the amplifier, read all safety instructions written on this manual;

If you are insecure about the installation of this equipment, get in touch with our tech support or with a professional specialized in car audio installation;

Before proceeding with the installation of any electric equipment on your vehicle, unplug the negative (-) terminal of the battery to avoid fires, injuries or damages;

Use your sound system safely. The continuous exposure to sound pressures over 85dB may cause irreversible hearing damage;

This equipment is for use in automotive DC voltage batteries between 12.6 and 14.4 volts. Before installing the equipment, check voltage of the batteries;

Do not install the amplifier in places exposed to water, dirt or humidity;

Choose a ventilated place to install the amplifier and avoid blocking the side ventilation windows;

Mount the amplifier in a secure way. Avoid mounting it on metallic parts of the vehicle, because it may cause ground looping (noise);

Make sure that the location chosen for the amplifier installation does not effect the operation of the vehicle;

When passing cables through metallic walls, use rubber O-rings to avoid cable cutting and short-circuits;

Clean the amplifier periodically with brush or dry cloth to assure the thermal efficiency of the heatsink;

This product may reach temperatures over 60°C/140°F. Make sure it is cold before touching it;

Be careful when making holes in the vehicle. Make sure you are not making holes in the fuel tank, brake lines or electrical cables of the vehicle;

Make sure the cables are properly secured throughout the installation;

Wear gloves, safety glasses and and all necessary PPE during the installation of SounDigital amplifiers.

The 35000.1EVOX must be supplied with +12VDC to +18VDC only when participating on the competitions. After the measurements, the fuses or circuit breakers must be switched OFF.



Warning!

THIS "WARNING" SIGN ALERTS THE USER OF IMPORTANT INFO. NOT FOLLOWING THIS INSTRUCTIONS MAY CAUSE INJURIES TO THE USER OR DAMAGE TO THE EQUIPMENT.

LOW BASS CORRECTION

The design of the EVOX line of amplifiers aims to give users the feeling of the smooth and deep bass, without compromise! Our Low Bass Correction technology compares the input signals to the amplifier against the output after the amplification stage, making real time correction of the signal, delivering a deeper bass with less distortion.



ULTRA COMPACT PCB

An intelligent layout, with great use of the PCB area and the use of modern components with reduced structure guarantee **SoundDigital** products a compact design, at the same time robust and with excellent thermal efficiency.

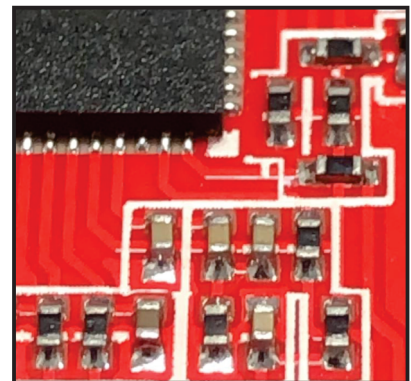

ROBUST CONSTRUCTION

Thinking about the application of power sports, the product has an extremely robust assembly, both the fixing points and the layout of the PCB were designed to withstand high vibrations, bumps and impacts.

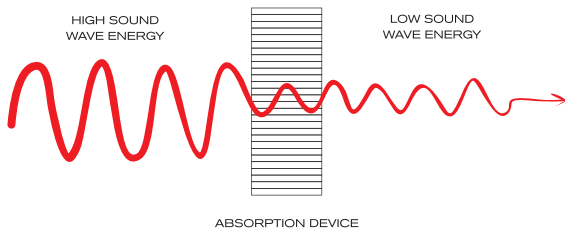

VIBRATION ABSORPTION DEVICE - VAD[®]

Our VAD[®] Technology reduces all impact caused by vibration on the electronic circuit board. This can include road vibration and even vibration caused by sound waves, increasing the reliability of our amplifiers.

REDUCED SIZE

The technology used in our amplifiers bring both high performance and power a compact chassis, providing flexible installation solutions for vehicles with limited space.

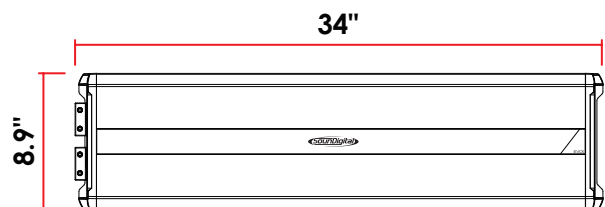
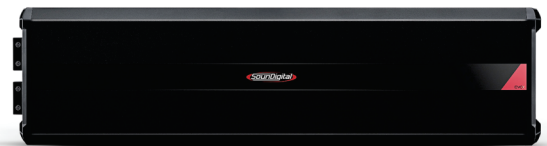

I-POWER SUPPLY

SounDigital amplifiers are known for their low consumption of battery, and this feature was improved on the **EVOX Line**. The new **I-POWER SUPPLY** is even more modern, which replaces the old toroidal transformers by a new generation of "E-E" core transformers delivers efficiency above 90%*, ensuring more hours of sound without battery recharge.

**Efficiency measured at power supply only*



The plastic covers have the function of finishing and hiding the amplifier fixing screws. To disassembling and assembling them, follow the instructions below.

DISASSEMBLING OF THE PLASTIC COVER

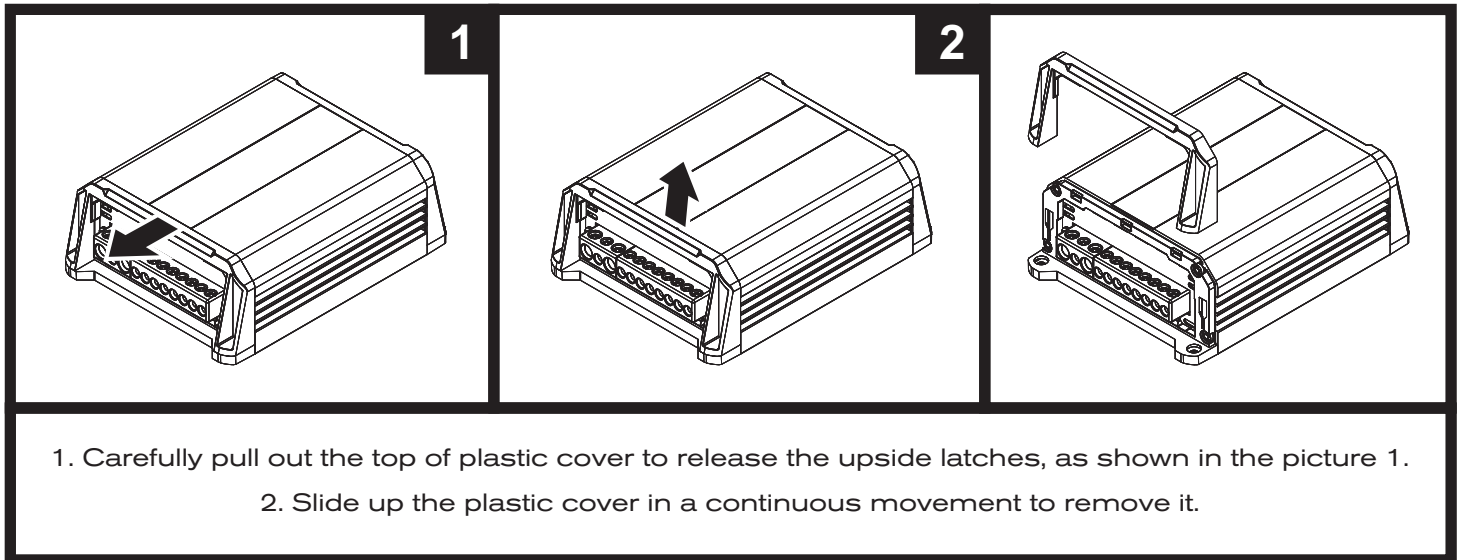

ASSEMBLING THE PLASTIC COVER

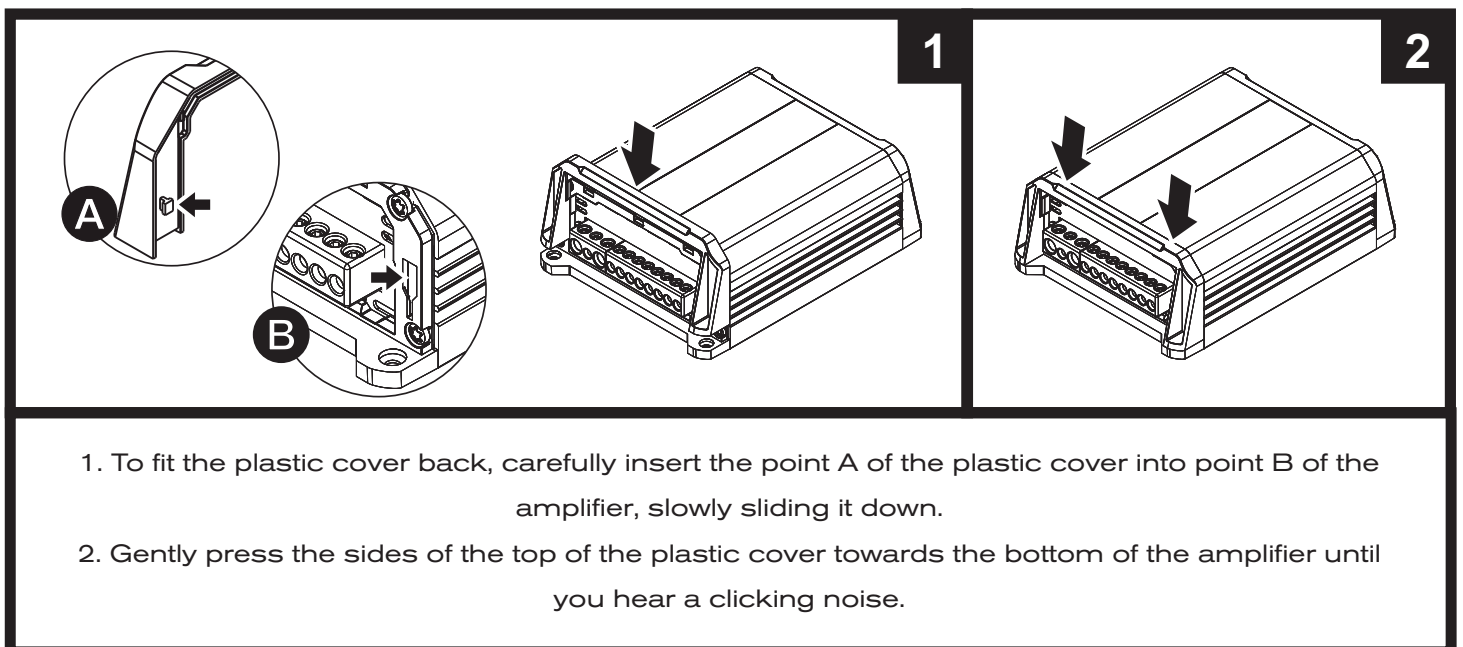

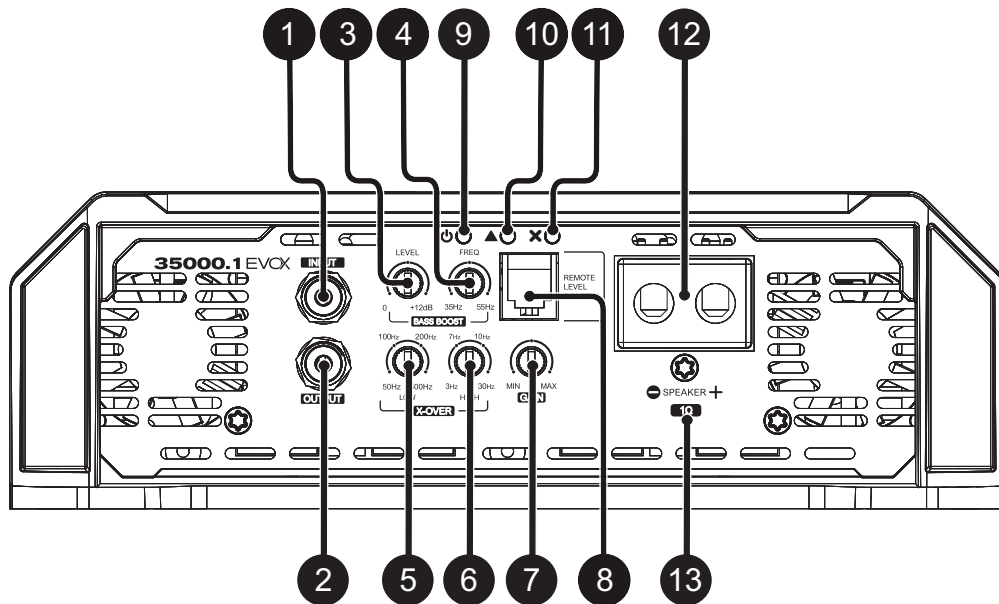

1	Input	Audio RCA connectors
2	Output	Audio RCA connectors
3	-	Variable Bass Boost Level Control (0dB ~ +12dB)
4	-	Variable Bass Boost Frequency Control (35Hz ~ 55Hz)
5	-	Variable Low Pass filter control (50Hz ~ 500Hz)
6	-	Variable Subsonic filter control (3Hz ~ 30Hz)
7	-	Variable Gain control
8	-	Remote level control connector
9	Blue	"Power ON" LED indicator
10	Yellow	"Clip" LED indicator
11	Red	"Protection" LED indicator
12	-	Speaker output connectors
13	-	Minimum speaker load allowed (impedance)

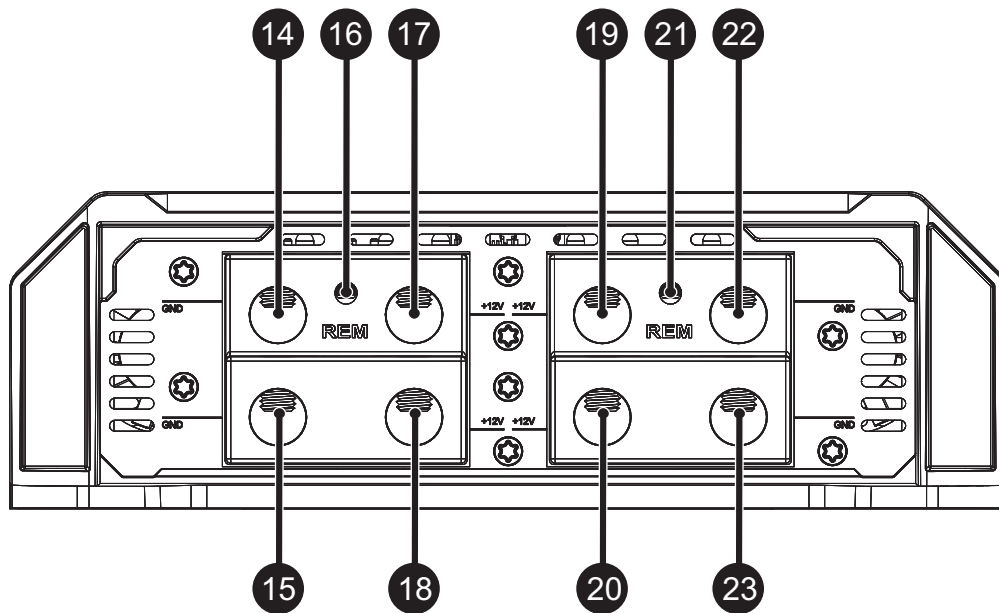

14	-	Negative power supply connector (GND)
15	-	Negative power supply connector (GND)
16	-	Remote power supply connector (REM)
17	-	Positive power supply connector (+12VDC)
18	-	Positive power supply connector (+12VDC)
19	-	Positive power supply connector (+12VDC)
20	-	Positive power supply connector (+12VDC)
21	-	Remote power supply connector (REM)
22	-	Negative power supply connector (GND)
23	-	Negative power supply connector (GND)

ELECTRICAL DIMENSIONING

For proper operation of your SoundDigital amplifier, you need the proper dimensioning of the electrical system and the cables used.

The table below shows the minimum section of GND cables, +12VDC cables and speaker output cables according to the power generated by the amplifier.

35000 WRMS	POWER CABLE	90mm ² - 000 AWG
	GROUND CABLE	
	SPEAKER CABLE	2 x 10mm ² - 7 AWG

We recommend the use of ONLY OFC (Oxygen Free Copper) Cables on the installation of our products.

RCA INPUTS

Example of one RCA cable connection only

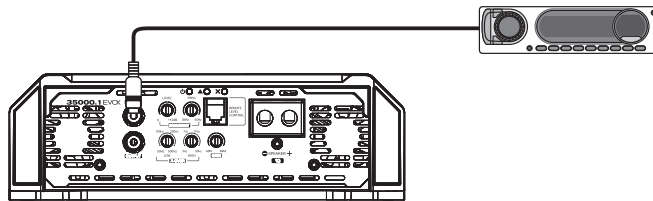

Example of two RCA cables connection (mono input).

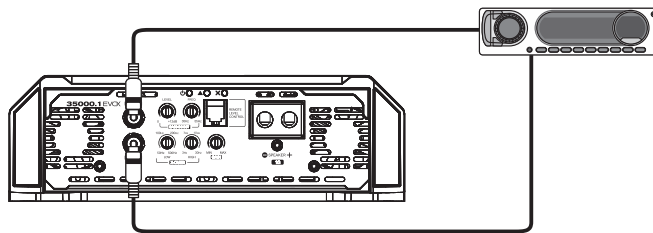

Example of one RCA cable connection only and using the RCA output to connect another amplifier.

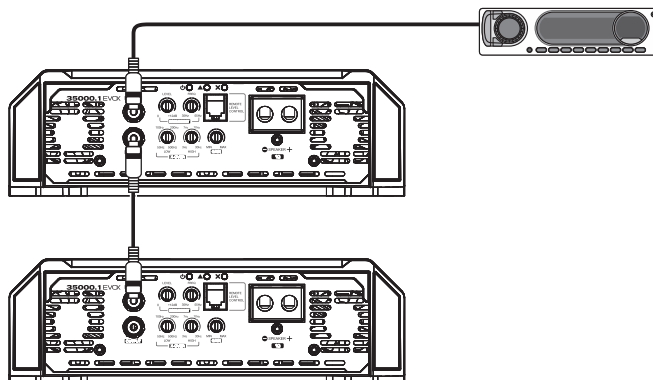

**Warning!**

BEFORE PROCEEDING WITH THE INSTALLATION, UNPLUG THE NEGATIVE TERMINAL FROM ALL OF THE BATTERIES, TO AVOID FIRE, DAMAGE TO THE AMPLIFIER AND THE USER HIMSELF.

- Mount the amplifier in such a way you have access to the connectors;
- Install the power cables in the vehicle properly, starting from the battery to the fuse holder or circuit breaker, use the cable with the appropriate size. Make all connections, install fuse holders or circuit breakers, but without placing the fuses or with the circuit breakers in the "OFF" position.

**Warning!**

THE MAXIMUM DISTANCE FOR THE INSTALLATION OF THE FUSE/CIRCUIT BREAKER IS 12 INCHES (30cm) AWAY FROM THE BATTERY.

- Connect the power cables in to the amplifier, observing the polarity. Connect all the positive cables from the fuse holder or circuit breaker to the positive connector of the amplifier and all the negative power cables from the batteries to the negative connector of the amplifier;
- The ground cable must be as short as possible and must be connected to the vehicle chassis and the battery negative;

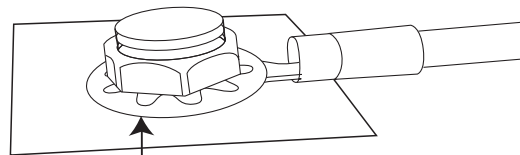

Remove the paint between the terminal and chassis

- Install the signal input cables in a proper way, distant from the power cables;
- Connect the RCA or the high level signal input cables to the head unit and amplifiers;
- Install the audio output cables with the appropriate section, distant from the power and audio input cables;
- Connect the audio output cables to the amplifier and speakers respecting the positive (+) and negative (-) polarities;
- Install the remote cable with the power cables, using 1.5mm² (15 AWG) cable or thicker;
- Connect the remote power cable to the amplifier's "REM" terminal at the main unit's remote power output (when not using the high level signal inputs);
- Before powering the system, verify all the connections and make sure there are no mistakes or short-circuits on the power and ground cables;
- Reconnect the ground of the batteries;
- Check if the head unit is turned off and then place the fuses in the fuse holders or switch the circuit breakers on;
- Turn on the main unit and the amplifier will turn on the "ON" LED indicating that it is in operation.

GAIN SETTING

Necessary equipment:

- Digital AC voltmeter;
- Media with sine wave test tone 60Hz recorded at 0dB;
- Screwdriver 1/8" (for gain set);
- On the CD player, set the fader control to center position;
- Set the variable "LOW" crossover in 500Hz and the "HIGH" in 3Hz;

Set up procedure

- Turn the gain control all the way down;
- Disconnect the output cables from the amplifier outputs;
- Turn off all processing (bass, treble, loudness, EQ, etc.);
- Set the source unit volume to 3/4 of full volume;
- Use a 60Hz sine wave;
- Increase the gain control until the "CLIP" LED starts blinking;
- Return the gain to the limit where the "CLIP" LED stops blinking and remains off;
- Once you have adjusted the amplifier to the correct voltage output, turn off the source unit and reconnect the speaker(s).

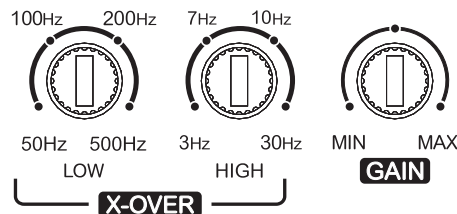

Download the tracks for set up in <https://soundigitalusa.com/tracks-for-set-up/>

Using Bass Boost

The Amplifier Bass Boost setting enables the user to boost the sound intensity at low frequencies of the sound system, where boost intensity can be adjusted, as well as the frequency of the region to be boosted, as indicated in the chart. This is a semi-parametric equalizer type circuit with "Q" value for the fixed filter, with an intensity boost adjustment from 0 to +12dB (16 times), and a central frequency adjustment of the filter between 35 and 55Hz, making it versatile for several types of sound systems.

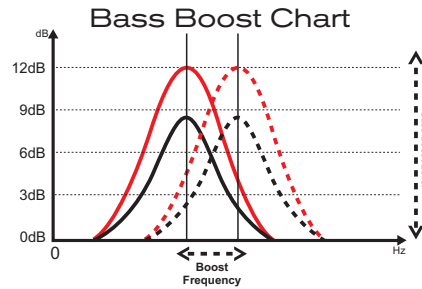

How to Adjust Bass Boost

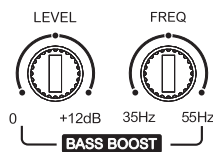

Reproduce your favorite song and set the variable frequency control to the frequency you want boost between 35Hz and 55Hz. Set boost intensity between 0dB and +12dB at the variable control Level.

How to Adjust the Crossovers

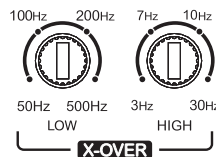

Set in the "HIGH" variable control between 3Hz and 30Hz ("A") where you want to perform the subsonic cut filter;

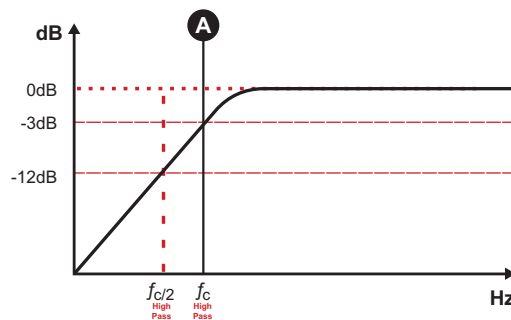

Set in the "LOW" variable control between 50Hz and 500Hz ("B") where you want to perform the low pass cut filter;

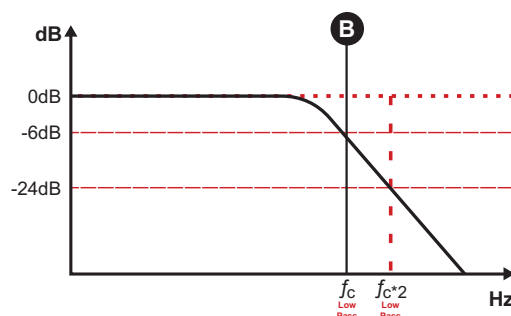



Unplug the negative (-) terminal of the battery before proceeding with any electrical installation in the vehicle to avoid fire starts, wounds or damage to the amplifier.

POWER CONNECTIONS

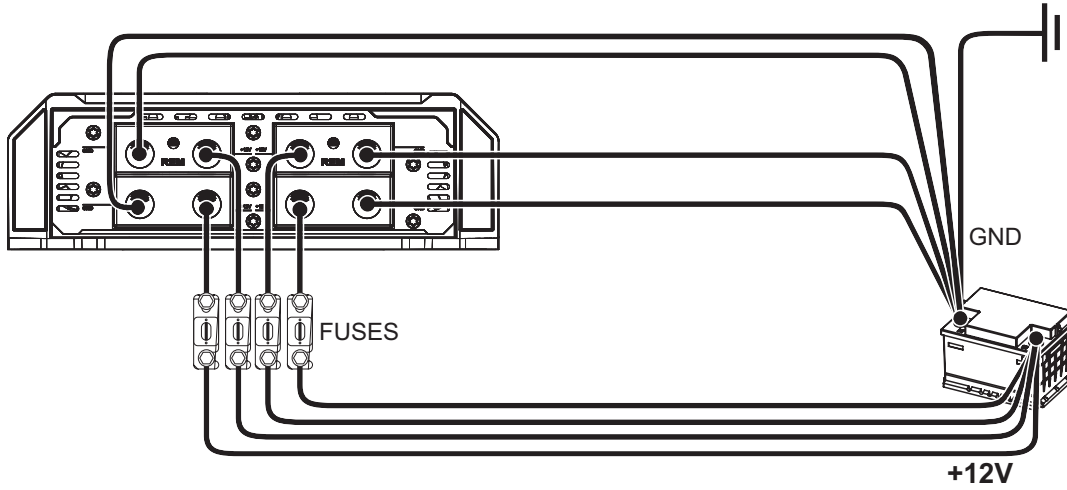

REMOTE INPUT CONNECTIONS

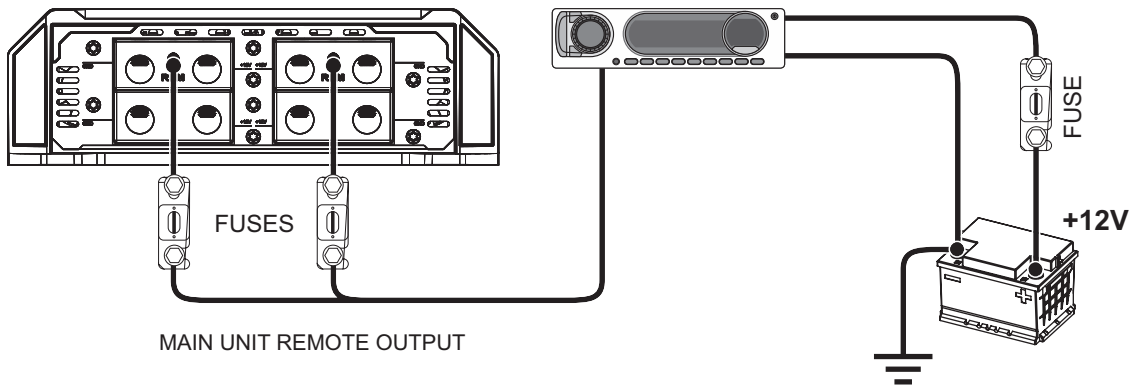

MAIN UNIT REMOTE OUTPUT

AUDIO INPUT AND OUTPUT CONNECTIONS

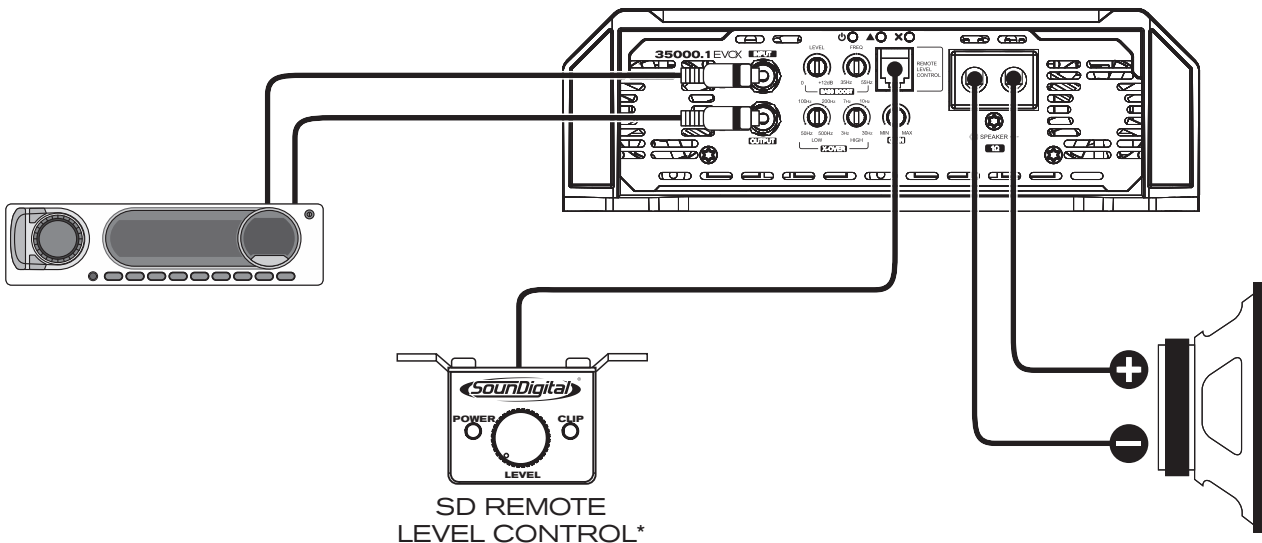

SD REMOTE LEVEL CONTROL*

*Sold separately

PARAMETERS	35000.1EVOX 1Ω
RMS Power @ 4Ω	1 x 15246W
RMS Power @ 2Ω	1 x 23100W
RMS Power @ 1Ω	1 x 35000W
Frequency Response (-3dB)	5Hz ~ 500Hz
Low Pass Filter (24dB/oct)	50Hz ~ 500Hz
Subsonic Filter (12dB/oct)	3Hz ~ 30Hz
Operating Voltage	8V ~ 18V
SNR	76dB
Input Sensitivity	1 ~ 4V
Current Draw (music)	N/A
Current Draw (max.)	3429A
Total Efficiency	81%
Damping Factor (@100Hz nominal impedance)	200
Power cable	90mm ² (000 AWG)
Audio output cable	2 x 10mm ² (7 AWG)
Fuse* (competition use)	3500A
Recommended Battery (minimum)	3500Ah

*It is mandatory to install the fuse at a maximum distance of 12 inches from the battery.

*Power at 12.6V @ 60Hz with a maximum THD of 1%.

DIMENSIONAL DATA

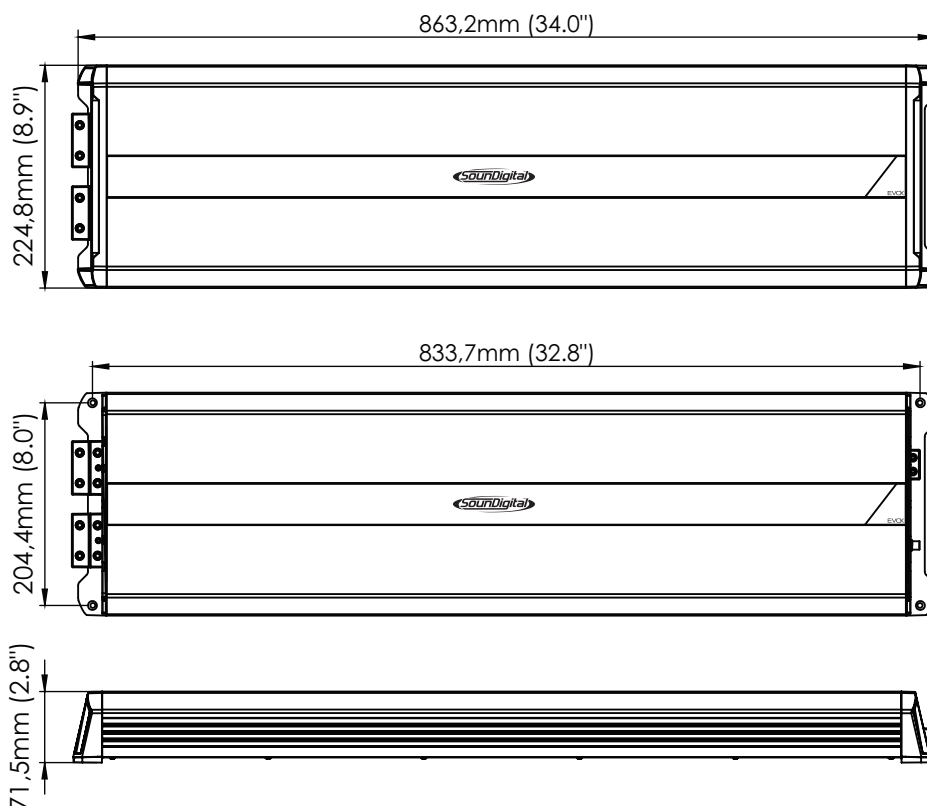

Gross Weight:
12,90 kg (28.44 lb)

Net Weight:
12,68 kg (27.95 lb)



YOUR MUSIC. **YOUR POWER.**



Consumer
Technology
Association™



WWW.SOUNDIGITALUSA.COM



[SOUNDIGITALUSA](https://www.facebook.com/SOUNDIGITALUSA)



[SOUNDIGITALUSA](https://www.instagram.com/SOUNDIGITALUSA)

CODE: 1000750352-002/AUG2022